

HETEROCLINIC NETWORKS IN HOMOGENEOUS AND HETEROGENEOUS IDENTICAL CELL SYSTEMS

M J FIELD

ABSTRACT. We prove results that enable realization of heteroclinic networks in coupled homogeneous and heterogeneous systems of identical cells. We also consider various models for network dynamics that allow variation in the number of inputs to identical cells.

Date: August 4, 2015.

1991 Mathematics Subject Classification. 37A250.

Research supported in part by NSF Grant DMS-1265253 & Marie Curie IIF Fellowship (Project 627590).

CONTENTS

| | |
|--|----|
| 1. Introduction | 2 |
| 2. Preliminaries and past work | 5 |
| 2.1. Heteroclinic cycles and networks | 5 |
| 2.2. Network dynamics and coupled cell systems | 10 |
| 2.3. Notation for synchrony classes and subspaces | 14 |
| 2.4. Additive input structure, Heterogeneous networks | 15 |
| 3. Two classes of identical cell homogeneous coupled cell systems that support heteroclinic networks | 18 |
| 3.1. 3-cell networks with two non-trivial synchrony subspaces | 18 |
| 3.2. The sequences $(\mathcal{P}_n)_{n \geq 3}$, $(\mathcal{Q}_n)_{n \geq 3}$ | 21 |
| 4. Realization of heteroclinic networks in \mathcal{P}_n and \mathcal{Q}_n | 23 |
| 4.1. Linearization at synchronized equilibria: architecture \mathcal{P}_n | 25 |
| 4.2. Linearization at synchronized equilibria: architecture \mathcal{Q}_n | 26 |
| 4.3. Constructing network compatible vector fields near $\Delta(\mathbb{R})$ | 26 |
| 4.4. Compatibility conditions for network vector fields | 27 |
| 4.5. Proof of Theorem 4.4 | 27 |
| 5. Additive input structure | 30 |
| 5.1. Heterogeneous Networks | 32 |
| 6. Generalizations | 34 |
| 7. Discussion and concluding comments | 36 |
| References | 38 |

1. INTRODUCTION

In this work we provide methods for constructing interesting realizations of heteroclinic cycles and networks in homogeneous and heterogeneous networks of identical coupled cells. We also address a number of general issues about the structure of networks of dynamical systems.

In the next section, we give a careful review of past work on heteroclinic networks, their realizations and their interest and significance. For the remainder of the introduction, we give basic definitions and describe our main results. Throughout, we let \mathbb{N} denote the (strictly positive) natural numbers and, given $n \in \mathbb{N}$, use the convention that $\mathbf{n} = \{1, \dots, n\}$.

Let $\Gamma(N, E) = \Gamma$ be a directed graph with $N \geq 2$ vertices, $\mathbf{v}_1, \dots, \mathbf{v}_N$, and directed edges e_α , $\alpha \in \mathbf{E}$. The edges connect vertices of Γ . If e_α is an edge from \mathbf{v}_j to \mathbf{v}_i , we often write $\mathbf{v}_j \rightarrow \mathbf{v}_i$ rather than e_α . Note,

however, that we allow multiple edges between vertices. Let d_i^{out} denote the *out*-degree of vertex \mathbf{v}_i : total number of edges from \mathbf{v}_i to other vertices. We may analogously define the *in*-degree d_i^{in}

Unless the contrary is indicated, we assume throughout the article that every graph Γ is directed and satisfies

- (C1) There are no self-connections $\mathbf{v}_i \rightarrow \mathbf{v}_i$, $i \in \mathbf{N}$.
- (C2) For every (ordered) vertex pair $\mathbf{v}_i, \mathbf{v}_j$, there is a chain of (directed) edges $\mathbf{v}_j \rightarrow \mathbf{v}_{k_1}, \mathbf{v}_{k_1} \rightarrow \mathbf{v}_{k_2}, \dots, \mathbf{v}_{k_s} \rightarrow \mathbf{v}_i$ joining \mathbf{v}_j to \mathbf{v}_i (note $i = j$ is allowed).

Conditions (C1, C2) imply that Γ is strongly connected and that every vertex lies on a cycle of length at least two.

Let $\Gamma(N, E) = \Gamma$ be a graph and M be a connected differential manifold of dimension at least two. We say that Γ has a *realization* as a heteroclinic network Σ in M , if we can choose a C^1 vector field X on M such that

- (H1) X has hyperbolic saddles $\mathbf{p}_i \in M$, $i \in \mathbf{N}$.
- (H2) Associated to every edge e_α from \mathbf{v}_j to \mathbf{v}_i , there is a unique X -trajectory $\phi_\alpha : \mathbb{R} \rightarrow M$ from \mathbf{p}_j to \mathbf{p}_i (that is, $\phi_\alpha(\mathbb{R}) \subset W^s(\mathbf{p}_i) \cap W^u(\mathbf{p}_j)$ and $\alpha \neq \beta$ implies $\phi_\alpha(\mathbb{R}) \neq \phi_\beta(\mathbb{R})$).
- (H3) $\Sigma = \bigcup_{i \in \mathbf{N}} \{\mathbf{p}_i\} \cup \bigcup_{\alpha \in \mathbf{E}} \phi_\alpha(\mathbb{R})$.

The realization is *robust* if (H1 – 3) hold for all C^1 vector fields Y in a C^1 open neighbourhood of X (we assume equilibria and connections depend continuously on the deformation Y of X).

It is easy to show that every graph Γ can be realized as a heteroclinic network in M if $\dim M \geq 4$ ($\Gamma(2, 8)$ cannot be realized in a 3-dimensional manifold if $d_1^{\text{out}} = 4$). Without further restrictions, robustness will always fail because cycles of intersecting stable and unstable manifolds (forced by (C2)) can always be destroyed by arbitrarily small C^∞ perturbations (transversality of invariant manifolds of hyperbolic equilibria is generic by the Kupka-Smale theorem [57]). However, if we restrict to classes of vector fields with additional structure, for example, equivariant vector fields or Lotka-Volterra population models, then there may be subspaces of M that are invariant for all vector fields in the class and this can lead to the presence of robust heteroclinic cycles and networks. In our case we are interested in the realization of robust heteroclinic cycles in networks of interacting dynamical systems and this will constrain the type of equilibria we consider.

We briefly review the idea of a (dynamical) network (more details are in the next section). Let \mathcal{N} be a network consisting of $\ell \geq 2$ nodes A_1, \dots, A_ℓ each with phase space M and denote the phase variable corresponding to the node A_i by $\mathbf{x}_i \in M$. We suppose dynamics on \mathcal{N}

is given by a C^1 vector field \mathbf{f} on M^ℓ . In terms of differential equations, we may write

$$(1.1) \quad \mathbf{x}'_i = f_i(\mathbf{x}_i; \mathbf{x}_{j_i(1)}, \dots, \mathbf{x}_{j_i(k_i)}), \quad i \in \ell.$$

We do not assume that k_i is independent of i – the network is *heterogeneous* – and the map $j_i : \mathbf{k}_i \rightarrow \ell$ need be neither injective nor surjective (even if $k_i \geq \ell$). The presence of the variable $\mathbf{x}_{j_i(s)}$ in the arguments of f_i means that the evolution of A_i depends on the state of $A_{j_i(s)}$ or, equivalently, that there is a ‘connection’ from $A_{j_i(s)}$ to A_i .

Associated to the network \mathcal{N} , we may define the network graph $G(\mathcal{N})$ to consist of ℓ -vertices a_i , corresponding to the nodes A_i , and edges e_α , $a_{j_i(s)} \rightarrow a_i$, for every $\alpha = (i, j_i(s))$, $s \in \mathbf{k}_i$. We allow self-edges – though they will not play a major role in what follows. We always assume that \mathcal{N} (that is, $G(\mathcal{N})$) is connected. We do not assume inputs are symmetric – the component functions f_i need not be symmetric functions of $\mathbf{x}_{j_i(1)}, \dots, \mathbf{x}_{j_i(k_i)}$.

If $f_i = f$, $k_i = k \geq 1$, for all $i \in \ell$, we say the network is a *homogeneous* network of identical cells.

Let \mathcal{N} be a homogeneous network of identical cells A_1, \dots, A_ℓ . Let $\Delta(M) = \{(\mathbf{x}_1, \dots, \mathbf{x}_\ell) \mid \mathbf{x}_1 = \dots = \mathbf{x}_\ell\}$ denote the diagonal subspace of M^ℓ (we also write $\Delta_\ell(M)$ if we need to emphasize the number of factors). The subspace $\Delta(M)$ is flow-invariant for all network vector fields and is partitioned into trajectories along which all cells are synchronized. Depending on the connection structure, there may be many other invariant subspaces, each of which will correspond to a subset (or subsets) of synchronized nodes. In some cases, the invariant subspace structure will support robust heteroclinic cycles and networks.

We may now state our main result.

Theorem 1.1. *Let M be any connected differential manifold. There exists a sequence $(\mathcal{P}_n)_{n \geq 3}$ of homogeneous networks, with \mathcal{P}_n having n nodes A_1, \dots, A_n and node phase space M , such that if $\Gamma(N, E) = \Gamma$ is a graph satisfying (C1, C2) then we can realize Γ as a robust heteroclinic network Σ in \mathcal{P}_{E+1} . Furthermore, if we denote the equilibria on Σ by \mathbf{p}_i , $i \in \mathbf{N}$, we have*

- (1) $\mathbf{p}_i \in \Delta_{E+1}(M)$, $i \in \mathbf{N}$. (The equilibria are all synchronized.)
- (2) If $\alpha \in E$ corresponds to a connection $\mathbf{p}_j \rightarrow \mathbf{p}_i$, then there exists $k = k(\alpha) \in \mathbf{E} + \mathbf{1}$ such that
 - (a)

$$\phi(\mathbb{R}) \subset P_k = \{\mathbf{x} \mid \mathbf{x}_a = \mathbf{x}_b, a, b \neq k\}.$$

(Node A_k desynchronizes from the other nodes along the connection $\mathbf{p}_j \rightarrow \mathbf{p}_i$.)

(b) If $\alpha, \beta \in E$, $\alpha \neq \beta$, then $k(\alpha) \neq k(\beta)$.

Remarks 1.2. (1) We prove theorem 1.1 in the most difficult case of 1-dimensional node dynamics ($M = \mathbb{R}$ or \mathbb{T}) and the vector fields we construct are C^∞ . The heteroclinic network structure persists under C^1 perturbations (by C^r network vector fields, $r \geq 1$).

(2) We may require *additive input structure* for the network \mathcal{P}_n – we give the definition in section 2.4. This allows for time varying connection structures [15].

(3) The network \mathcal{P}_3 previously appeared in [6, §5] in connection with the existence of heteroclinic cycles in coupled cell systems.

(4) Theorem 1.1 has some formal resemblance with the result on cylinder realization in Ashwin & Postlethwaite [13, Proposition 2] though their results do not address realization in identical cell networks (see also the general discussion in section 2).

We also have partial results related to theorem 1.1 that apply to heterogeneous networks (for which $\Delta(M)$ may or may not be an invariant subspace) as well as different realizations of Γ in \mathcal{P}_n which connect equilibria which are not fully synchronized.

We conclude by describing the contents of the paper by section. In section 2, we give an overview of heteroclinic cycles and networks as well as review past work on the realization problem. We conclude the section with generalities on networks of coupled dynamical systems. In section 3 we construct the sequence (\mathcal{P}_n) referred to in theorem 1.1 (and also a related sequence (\mathcal{Q}_n)). In section 4, we prove theorem 1.1. In section 5, we prove that theorem 1.1 continues to hold with the assumption of additive input structure and also show how to apply our results to heterogeneous networks. In section 6 we discuss generalizations where we connect groups of synchronized cells, rather than fully synchronized equilibria. We conclude in section 7 with discussion and a description of some outstanding problems. Readers who are familiar with heteroclinic networks and coupled cell systems should probably skim quickly through the background material in section 2.

2. PRELIMINARIES AND PAST WORK

2.1. Heteroclinic cycles and networks. We start with a definition of a heteroclinic network that suffices for our needs.

Definition 2.1. Let X be a C^1 vector field on the connected differential manifold M . A compact, connected, flow invariant subset $\Sigma \subset M$ is a

heteroclinic network if we can write

$$\Sigma = \bigcup_{i \in I} \mathbf{p}_i \cup \bigcup_{b \in J} \gamma_b(\mathbb{R})$$

where

- (1) $\mathbf{S} = \{\mathbf{p}_i \mid i \in I\}$ is a finite non-empty set of hyperbolic saddle equilibria for X .
- (2) $\mathbf{C} = \{\gamma_b : \mathbb{R} \rightarrow M \mid b \in J\}$ is a finite set of connecting trajectories between equilibria in \mathbf{S} satisfying the conditions
 - (a) For every $\gamma_b \in \mathbf{C}$, there exist $\mathbf{p}_i, \mathbf{p}_j, i \neq j$, such that γ_b is a connection from \mathbf{p}_j to \mathbf{p}_i ($\gamma_b(\mathbb{R}) \subset W^u(\mathbf{p}_j) \cap W^s(\mathbf{p}_i)$).
 - (b) For every ordered pair $\mathbf{p}_i, \mathbf{p}_j \in \mathbf{S}$, there exists a sequence of connections $\mathbf{p}_j \rightarrow \mathbf{p}_{k_1}, \mathbf{p}_{k_1} \rightarrow \mathbf{p}_{k_2}, \dots, \mathbf{p}_{k_s} \rightarrow \mathbf{p}_i \in \mathbf{C}$, with $s \geq 1$ and $k_1, \dots, k_s \neq i, j$.

If Σ contains an equal number of equilibria and connections, Σ is a *heteroclinic cycle*. If $W^u(\mathbf{p}_i)$ is 1-dimensional for all $i \in I$, we say Σ is a simple heteroclinic network (or cycle).

Remarks 2.2. (1) If Σ is a heteroclinic network then every equilibrium point of Σ lies on a cycle of length at least two.

(2) For our definition, we deny homoclinic loops (no self-connections).

(3) If Σ is a heteroclinic cycle, then the number of connections equals the number of equilibria. In the case of G -equivariant systems, a G -invariant heteroclinic network Σ is usually called a heteroclinic cycle if Σ is the G -orbit of a heteroclinic cycle. If Σ/G is a homoclinic loop, it is common to call Σ a *homoclinic cycle*.

(4) If we let $\Gamma(|I|, |J|) = \Gamma$ have vertices $\mathbf{v}_i, i \in I$, and require the number of connections from \mathbf{v}_j to \mathbf{v}_i to be $|\{\gamma_b \mid \gamma_b(\mathbb{R}) \subset W^u(\mathbf{p}_j) \cap W^s(\mathbf{p}_i)\}|$, then Γ satisfies (C1, C2) and Σ will be a realization of Γ .

Heteroclinic and homoclinic cycles can occur in low codimension bifurcations of vector fields and have been intensively studied by many authors (see, for example, the volumes by L Shilnikov *et al.* [62, 63]). Of particular interest are the mechanisms whereby homoclinic bifurcations can lead to complex dynamics and chaos. In a related direction that dates back to Duffing [21], and follows on earlier work by Wang & Ott [65], Mohapatra & Ott have recently shown how periodic forcing of homoclinic loops and heteroclinic cycles can lead to the formation of non-uniformly hyperbolic attractors [52] – these works address the difficult problem of finding explicit examples of non-uniform hyperbolicity and build on earlier work of L-S Young *et al.* on shear induced chaos and rank one attractors [48, 66].

On account of the Kupka-Smale theorem, *robust* heteroclinic cycles and networks only occur when vector fields possess additional structure which is invariably associated with the presence of invariant subspaces. They are a well-known phenomenon in models of population dynamics, ecology and game theory based on the Lotka-Volterra equations (for example, [49, 37, 38, 39, 40]). Typically, these systems are defined on a simplex or the positive orthant $\mathbb{R}_+^n = \{x \in \mathbb{R}^n \mid x_i \geq 0, i = 1, \dots, n\}$ and have the ‘extinction’ hyperplanes $x_i = 0$ as invariant subspaces. The first example of a heteroclinic cycle that the author is aware of in the literature appears in the 1975 paper by May & Leonard [49]¹ – and has been used to model the ‘rock-paper-scissors’ game and winnerless competition (for example, [49, 16, 2, 59]).

Another large and well-studied class of dynamical systems with invariant subspaces are differential equations which are *equivariant* with respect to a compact Lie group of symmetries (for example, [60, 50, 46, 25, 47, 45, 12, 26, 29]). Robust heteroclinic cycles and networks occur because generic intersections of stable and unstable manifolds of equilibria in equivariant dynamics need not be transverse [22, 23, 24]. This breakdown of transversality is closely associated with a rich invariant subspace structure. Specifically, if a finite or compact Lie group G acts smoothly on the phase space M , and H is any non-empty subset of G , then the submanifold $M^H = \{x \in M \mid hx = x, \forall h \in H\}$ is invariant by the flow of every C^1 G -equivariant vector field on M .

From the mathematical point of view, robust heteroclinic networks often lead to interesting complex dynamics. For example, the phenomenon of random *switching* between nodes [41, 7, 10, 42]. Evidence of heteroclinic switching has even been observed *in vivo* in Abeles *et al.* [1]. From the point of view of applications, there has been recent interest in robust heteroclinic cycles that appear in neural microcircuits where they give nonlinear models with ‘winnerless competition’ – there is a local competition between different states but not necessarily a global winner [58]. These models seem useful for explaining sequence generation and spatio-temporal encoding and have been found in rate-based [3] and other models [55]. They can also be found in phase oscillator models derived from Hodgkin-Huxley models [35] or more general phase oscillator models [11]. Heteroclinic networks can be used to perform finite-state computations in phase oscillator systems [8, 10] (see also [53, 54] for pulse coupled systems). Analogous behaviour is also found in hybrid models of neural systems such as the networks of

¹Interest has continued since that time notwithstanding the authors remark that “Biologically, the behaviour illustrated in Figs. 4 and 5 is nonsense”.

unstable attractors in systems of delay-pulse coupled oscillators [51] as well as in coupled chemical reaction systems [43].

The class of equivariant dynamical systems is very large and, of course, many of the possible groups and group actions appear quite uninteresting for applications. It is useful to define a subclass of group actions that results in heteroclinic cycles and networks that naturally complement those occurring in Lotka-Volterra models. Let Δ_n denote the group of diagonal matrices acting on \mathbb{R}^n

$$\Delta_n = \text{diag}(\pm 1, \dots, \pm 1) \approx \mathbb{Z}_2^n.$$

Let H be a subgroup of S_n (the symmetric group on n symbols acting on \mathbb{R}^n by permutation of coordinates) and define the group $G \subset O(n)$ to consist of all linear maps $A : \mathbb{R}^n \rightarrow \mathbb{R}^n$ of the form

$$A(x_1, \dots, x_n) = (\pm x_{\sigma(1)}, \dots, \pm x_{\sigma(k)}), \quad ((x_1, \dots, x_k) \in \mathbb{R}^k),$$

where $\sigma \in H$ (G is a group of signed permutation matrices). We may write G as the semidirect product $\Delta_n \rtimes H$. If H is the trivial subgroup $\{e\}$, we obtain the action of Δ_n on \mathbb{R}^n . The case $n = 3$, leads to the first explicit example of robust heteroclinic cycles in equivariant dynamics by dos Reis [60]. Much later, the case $n = 4$ led to one of the first investigations of a robust heteroclinic network by Kirk and Silber [44]. There is a rich theory for heteroclinic cycles and networks when H is a transitive subgroup of S_n (and G acts irreducibly on \mathbb{R}). We refer to [29] for details and more references as well as to Dias *et al.* [17] who investigate more general linear actions by wreath products.

We may define a natural class of dynamical systems on \mathbb{R}^n (more generally $\prod_{i=1}^k \mathbb{R}^{m_i}$) intermediate between Lotka-Volterra systems and actions of groups of signed permutation matrices on \mathbb{R}^n . This class will have a natural connection with network dynamics.

Definition 2.3 ([26, Chapter 7],[28]). A *semi-linear feedback system* on \mathbb{R}^n is a system of differential equations of the form

$$x'_i = f_i(x_i) + x_i F_i(x_1, \dots, x_{i-1}, x_{i+1}, \dots, x_n), \quad i \in \mathbf{n}$$

where $f_i(0) = 0$, $i \in \mathbf{n}$, and the maps f_i, F_i are all at least C^1 .

Remarks 2.4. (1) Lotka-Volterra systems define semi-linear feedback systems on \mathbb{R}^n (typically with F_i linear, $f_i(x_i) = a_i x_i - b_i x_i^2$, and $a_i, b_i > 0$).

(2) Signed permutation group actions $G = \Delta_n \rtimes H$ on \mathbb{R}^n define semi-linear feedback systems if we restrict to cubic truncations (this usually suffices for the study of heteroclinic cycles, see [29, Chapter 5]). In this situation f_i will be a odd cubic map $f_i(x_i) = a_i x_i - b_i x_i^3$ (with all the

f_i equal if H is transitive).

(3) The ‘extinction’ hyperplanes $x_i = 0$ are invariant for semi-linear feedback systems.

(4) In general, we may define semi-linear feedback systems on $\mathbb{R}^m = \prod_{i=1}^n \mathbb{R}^{m_i}$ in the obvious way by replacing $x_i F_i$ by $\langle \mathbf{x}_i, \mathbf{F}_i \rangle_i$, where $\langle \cdot, \cdot \rangle_i$ is an \mathbb{R}^{m_i} -valued bilinear form on \mathbb{R}^{m_i} . In this case, the subspaces $\mathbf{x}_i = 0$ are invariant.

For a semi-linear feedback system, the evolution of x_i according to $x_i' = f_i(x_i)$ is modified by the linear feedback term $x_i F_i$ which may depend nonlinearly on the remaining variables, see figure 1. The feedback

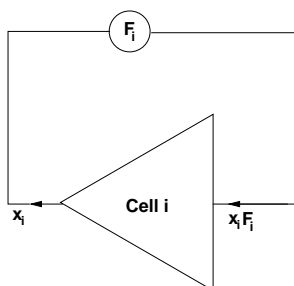

FIGURE 1. The model for a semi-linear feedback system

loop can lead to bistability of equilibria on the x_i -axes. For example, in the Lotka-Volterra case, f_i has equilibria at $x_i = 0, a_i/b_i > 0$. Along a trajectory $\bar{\mathbf{x}} = (x_1, \dots, x_{i-1}, x_{i+1}, \dots, x_n)$, variation of $x_i F_i(\bar{\mathbf{x}})$ can result in switching between a single stable equilibrium at $x_i = 0$ and a stable equilibrium at $x_i > 0$. This mechanism easily leads to the formation of heteroclinic cycles. We refer to [26, Chapter 7, §2] where this approach is used to construct edge and face heteroclinic cycles in symmetric systems (though symmetry plays no essential role, see [26, 28]). In recent work, Ashwin & Postlethwaite [13] have shown that every heteroclinic network, with cycle lengths at least three, can be realized in a semi-linear feedback network. The realization is achieved using explicit cubic vector fields (with F_i linear in $x_j^2, j \neq i$).

Heteroclinic cycles (or networks) that occur for Lotka-Volterra equations or semi-linear feedback systems have the following network interpretation. Equilibria on the cycle correspond to groups of saturated (fully active) nodes and dead nodes. For example, the equilibrium $(1, 0, 0)$ will correspond to one saturated node (the first), and two dead nodes. An equilibrium of the form $(a, b, 0, 0)$, with $a, b > 0$, corresponds to two saturated nodes and two dead nodes. If $(1, 0, 0)$ lies on a heteroclinic cycle, which has a connection $(1, 0, 0) \rightarrow (0, 1, 0)$, then along the

connection node 3 will be dead, node 1 will be active and damped, and node 2 will be active and growing.

From the point of view of much contemporary research on networks, in particular neural dynamics, it is interesting to consider networks of coupled nonlinear oscillators and look for patterns of synchronization. The simplest models of this type are Kuramoto style coupled phase oscillators where node dynamics is defined on the circle $\mathbb{T} = \mathbb{R}/\mathbb{Z}$. In this context, the previously described models of heteroclinic networks comprised of connections between equilibria are not directly relevant as nodes cannot be naturally grouped into dead and active/saturated. One approach, due to Ashwin & Swift [14], is to look at all-to-all coupled systems of n -cells with S_n symmetry where there is often synchronization into clusters of cells combined with heteroclinic phenomena (see, for example, [36, 56, 10]). We instead consider networks of interacting dynamical systems with no symmetries (local or global) but where the network architecture can lead to invariant subspaces comprised of groups of synchronized cells. An advantage of this approach is that we avoid higher multiplicity of eigenvalues resulting from the group action and the unavoidable S_n -invariance of heteroclinic cycles and networks.

2.2. Network dynamics and coupled cell systems. A general theory of networks of coupled cells has been formalized by Stewart, Golubitsky and coworkers [64, 32, 34] (a survey and review of some of this work appears in [33]). Their approach is relatively algebraic in character and depends on groupoid formalism, graphs and the idea of a quotient network. Although we use some of their formalism and terminology, we follow a more synthetic and combinatorial way of describing coupled systems that fits better with our intended applications of constructing networks with particular properties – for example, additive input structure, intrinsic cell dynamics and realistic coupling models. We use a ‘flow-chart’ formalism similar to that used in electrical and computer engineering. We give necessary definitions, establish notational conventions and refer the reader to [4, 6, 5, 27] for more details, discussion and examples. We remark that we generally use the term *coupled cell network* to refer to the network architecture – a directed network graph codifying the connection structure and node types – and use *coupled cell system* to refer to a specific realization of a coupled cell network as a system of coupled differential equations [4]. On occasions, it is convenient to abuse this convention and allow network structure notation to represent a coupled cell system.

Recall from the introduction that dynamics on a network \mathcal{N} with $\ell \geq 2$ nodes (or ‘cells’) A_1, \dots, A_ℓ , each with same phase space M , is given by a C^1 vector field \mathbf{f} on M^ℓ . In terms of differential equations, we have

$$(2.2) \quad \mathbf{x}'_i = f_i(\mathbf{x}_i; \mathbf{x}_{j_i(1)}, \dots, \mathbf{x}_{j_i(k_i)}), \quad i \in \ell.$$

We do not yet assume that k_i is independent of i – the network is *heterogeneous*.

Remarks 2.5. (1) At this level of generality, nothing is said about the *input structure* or *intrinsic* node dynamics (see [15, §2] for an extended discussion on this point and the role of reductionism).

(2) The model assumes that the evolution of each node depends on *complete information about the states* of the other nodes. This is an unrealistic assumption for most systems. For example, in biology, technology and control, communication of information is expensive (in terms of energy and resources devoted to communication channels) and efficiency is obtained through communicating the essential minimal information for the task in hand. One more realistic approach is to assume that each node A_i has an associated observable $\xi_i : M \rightarrow \mathbb{R}^s$ (often with $s = 1$) and that network equations are of the form

$$\mathbf{x}'_i = f_i(\mathbf{x}_i; \xi_{j_i(1)}(\mathbf{x}_{j_i(1)}), \dots, \xi_{j_i(k_i)}(\mathbf{x}_{j_i(k_i)})), \quad i \in \ell.$$

This is the *scalar signalling model* described in [4, §2.5] which allows for situations where there is only partial communication of information between nodes, such as pulse coupling or spiking models. Scalar signalling models are also appropriate for situations where the node phase spaces vary across the network or there is a diffusive or additive input structure. None of this matters in the simplest case when M is 1-dimensional (\mathbb{R} or \mathbb{T}) since the tangent bundle $TM \approx M \times \mathbb{R}$ and we may always assume evolution depends on 1-dimensional node states. The 1-dimensional case will be of primary concern in this article and so we assume the model given by (2.2) rather than the more realistic scalar signalling model. We discuss extensions of our main results to scalar signalling networks in the concluding section of this paper.

We regard each node of a network as a cell with a possibly variable number of inputs and an output. Diagrammatically, we represent a cell as shown in figure 2. Referring to figure 2, cell A_i receives single inputs from the cells A_2, A_7, A_9 and three inputs from A_3 ($k_i = 6$). The identical arrowheads indicate that inputs 2 and 3 are the same (and so the connections from A_3, A_9 can be interchanged without affecting the dynamics or network structure). The remaining inputs are all different

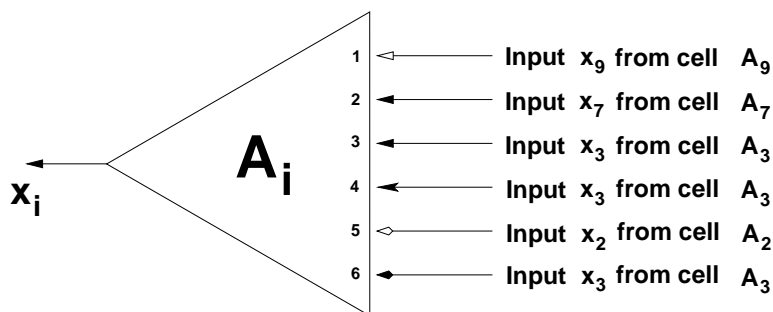

FIGURE 2. A cell with six inputs and one output. Inputs of the same type (for example the second and third input) can be permuted without affecting the output.

(and any interchange of inputs to 1, 4–6 will potentially change the dynamics and certainly changes the network structure). We shall mainly be concerned with the case of *asymmetric inputs* [4]: no inputs can be interchanged without changing network dynamics – rather than the case of symmetric inputs [5]. We explain why shortly.

Since we are assuming all cells have the same phase space, any cell can be connected to any input of any other cell in the network. A coupled cell network \mathcal{N} will then consist of the cells A_i together with connections between cells. If each cell has a fixed number of inputs, then we require that all inputs are filled. Associated to the coupled cell network \mathcal{N} , we define the network graph $G(\mathcal{N})$ exactly as in the introduction. We always assume that \mathcal{N} (that is, $G(\mathcal{N})$) is connected.

If $f_i = f$, $k_i = k \geq 1$ for all $i \in \ell$, the network is a *homogeneous network* (of identical cells²).

Let \mathcal{N} be a homogeneous network with cells $\mathbf{A} = \{A_1, \dots, A_\ell\}$. Suppose that $\mathcal{X} = \{X^j \mid j \in \mathbf{p}\}$ is a partition of \mathbf{A} such that each X^j contains at least one cell and at least one X^j contains two or more cells. Let $d(j) = |X^j|$ be the number of cells in X^j , $j \in \mathbf{p}$. Label cells in X^j as $A_{j_1}, \dots, A_{j_{d(j)}}$ and define $J_j = \{j_1, \dots, j_{d(j)}\}$. We have $\cup_{j \in \mathbf{p}} J_j = \ell$.

If $\mathbf{x} = (\mathbf{x}_1, \dots, \mathbf{x}_n) \in M^\ell$ denotes the state of the network, then we may group states according to the partition \mathcal{X} and write

$$\mathbf{x} = (\mathbf{x}^1, \dots, \mathbf{x}^p),$$

²We allow either asymmetric or symmetric inputs

where $\mathbf{x}^j = (\mathbf{x}_{j_1}, \dots, \mathbf{x}_{j_{d(j)}}) \in M^{d(j)}$ will denote the state of the $d(j)$ cells in X^j . Define

$$\Delta_j = \{\mathbf{x}^j \mid \mathbf{x}_{j_1} = \dots = \mathbf{x}_{j_{d(j)}}\}, \quad j \in \mathbf{p}$$

and

$$\Delta(\mathcal{X}) = \{\mathbf{x} = (\mathbf{x}^1, \dots, \mathbf{x}^p) \mid \mathbf{x}^j \in \Delta_j, \quad j \in \mathbf{p}\}.$$

Definition 2.6 ([6, 4], cf [64, 34, 33]). The partition \mathcal{X} is a *synchrony class* for the coupled cell network \mathcal{N} if the subspace $\Delta(\mathcal{X})$ is dynamically invariant for every realization of \mathcal{N} as a coupled cell system. If \mathcal{X} is a synchrony class then we say $\Delta(\mathcal{X})$ is a *synchrony subspace* or *invariant subspace*.

If the network is homogeneous, then $\mathcal{X} = \{A_1, \dots, A_\ell\}$ is always a synchrony class: the *maximal synchrony class*. The associated invariant space is the *trivial* or *minimal synchrony subspace* and is the synchrony subspace of minimal dimension for any given realization of a coupled cell network (this should be contrasted with the *null synchrony class* which is the set-theoretic complement of the union of all synchrony classes and is the open invariant set consisting of desynchronized cells). We usually denote the minimal synchrony subspace by $\Delta(M)$ (or $\Delta_\ell(M)$ if we wish to emphasize the number of cells).

We remark the following elementary proposition characterizing synchrony classes.

Proposition 2.7 (cf [33, §7]). *Let \mathcal{N} be a coupled cell network as above. Suppose that $\mathcal{X} = \{X^j \mid j \in \mathbf{p}\}$ is a partition of \mathbf{A} . Then \mathcal{X} is a synchrony class iff for all $i, j \in \mathbf{p}$ and every input type k , every cell in X^i receives the same number of inputs of type k from cells in X^j .*

Proof. One implication is an immediate consequence of the existence and uniqueness theorem for differential equations.

For the converse, it is enough to show that if the condition fails then \mathcal{X} cannot define an invariant subspace for all systems with the given architecture. It is enough to find one example. Our assumption is that there exist $i, j \in \mathbf{p}$ and an input type ℓ such that there exists two cells A_a, A_b in X^i which receive a different number of inputs of type ℓ from cells in X^j . Suppose cells have r_ℓ inputs of type ℓ . Without loss of generality, take $\ell = 1$ and set $r_\ell = r$. Assume the phase space is \mathbb{R} and take as model $f(x_0; x_1, \dots) = x_1 + x_2 + \dots + x_r$ (sum linearly over inputs of type ℓ). Initialize cells in X^j so that their initial state is $1 \in \mathbb{R}$. Initialize to zero cells not in X^j (note the case $i = j$ is covered). Observe that the value of the model function f will be different on the

two cells A_a, A_b (f sums to the number of inputs of type ℓ from cells in X^j). Hence \mathcal{X} is not a synchrony class. \square

2.3. Notation for synchrony classes and subspaces. Let $\Delta(\mathcal{X})$ be the synchrony subspace determined by the synchrony class $\mathcal{X} = \{X^j \mid j \in \mathbf{p}\}$. Let $\mathcal{X}' = \{X^j \mid d(j) > 1\}$. Each $X^j \in \mathcal{X}'$ corresponds to a group of at least two cells. If $\mathcal{X}' = \{X^{j_1}, \dots, X^{j_k}\}$, we denote the synchrony subspace (or class) by $\{X^{j_1} \parallel X^{j_2} \parallel \dots \parallel X^{j_k}\}$. Typically, we expand each X^{j_i} to identify the individual cells. For example, suppose that $\mathcal{X}' = \{X^1, X^2\}$ and $X^1 = \{A_1, A_2, A_5\}$, $X^2 = \{A_3, A_4\}$, then we denote the associated synchrony subspace by $\{A_1, A_2, A_5 \parallel A_3, A_4\}$. The notation indicates that both groups of cells A_1, A_2, A_5 and A_3, A_4 may be synchronized, but not necessarily to the same state. Indeed, $\{A_1, A_2, A_3, A_4, A_5\}$ may not be a synchrony class (see [6, §7.1] for a simple example).

Example 2.8. In figure 3 we show two identical cell networks comprised of three cells, each cell with two inputs. Suppose first that the cells have symmetric inputs. Then the two networks are dynamically identical (see [4, §3] for formal definitions). Both networks have $\{A_1, A_2\}$, $\{A_1, A_3\}$, and $\{A_2, A_3\}$, as non-trivial synchrony classes.

Now suppose that the cells in both networks have asymmetric inputs. Then the two networks are dynamically different. Indeed, the network of figure 3 (a) has two non-trivial synchrony classes $\{A_1, A_2\}$, $\{A_1, A_3\}$, while the second network has *no* non-trivial synchrony classes.

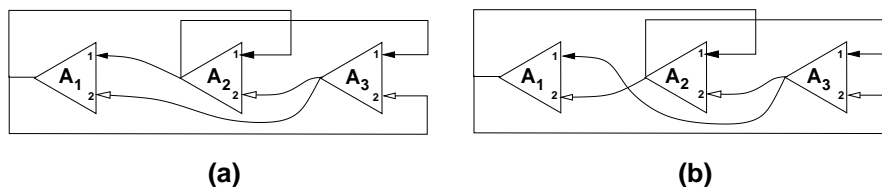

FIGURE 3. Two 3 identical cell networks, each cell with two inputs.

Based on the invariant subspace structure, one might guess that robust heteroclinic cycles are most likely when inputs are symmetric. This turns out not to be so: there are no robust heteroclinic cycles when there are symmetric inputs. This is a consequence of multiplicities forced in eigenvalues at fully synchronized equilibria. On the other hand when there are asymmetric inputs, the network of figure 3(a) supports robust simple heteroclinic cycles, even when M is 1-dimensional.

We refer to [6, §5] and the next section. We remark that robust heteroclinic networks can occur in systems of at least four all-to-all symmetrically coupled phase oscillators (see [9, 10] but note the restrictions placed on coupling functions). On account of eigenvalue multiplicities, which are often absent in systems with asymmetric inputs, we concentrate on realizing heteroclinic networks in networks of identical cells with asymmetric inputs.

2.4. Additive input structure, Heterogeneous networks. While the all-to-all coupled identical cell model is attractive mathematically, it is not very realistic in some applications. In particular, we are interested in networks for which cells have well defined dynamics when uncoupled and to which one can add (or subtract) inputs in a coherent way. We give a general definition of additive input structure which is applicable to general networks, and then specialize to systems that can synchronize into clusters and have a weak form of diffusive coupling.

Definition 2.9. Suppose that \mathcal{N} is a dynamical network with cells A_1, \dots, A_ℓ and dynamics given by

$$\mathbf{x}'_i = f_i(\mathbf{x}_i; \mathbf{x}_{j_i(1)}, \dots, \mathbf{x}_{j_i(k_i)}), \quad i \in \ell.$$

The network (or cells) has *additive input structure* if there exist $P \in \mathbb{N}$, C^1 families of vector fields $h_j : M \times M \rightarrow TM$, $j \in \mathbf{P}$, and maps $\tau^i : \mathbf{k}_i \rightarrow \mathbf{P}$, $i \in \ell$, such that

$$(2.3) \quad f_i(\mathbf{x}_i; \mathbf{x}_{j_i(1)}, \dots, \mathbf{x}_{j_i(k_i)}) = \sum_{s=1}^{k_i} h_{\tau^i(s)}(\mathbf{x}_i, \mathbf{x}_{j_i(s)}), \quad i \in \ell.$$

Remarks 2.10. (1) We regard the second variable of h_j as the parameter: $h(\mathbf{x}, \mathbf{y}) \in T_{\mathbf{x}}M$ for all $\mathbf{y} \in M$.

(2) If $P = 1$, then the network has *symmetric* inputs – there is just one input type. If the maps τ^i are all injective and at least one $k_i > 1$, then the network will have *asymmetric* inputs.

(3) The additive input structure allows the addition and deletion of connections. In particular, the connection structure may be time dependent (cf. [15]).

Additive input structure requires there are no nonlinear interactions between different inputs to the cell A_i though each input may certainly interact in a nonlinear way with the state variable x_i . Kuramoto style phase oscillator networks, most pulse coupled networks, and the N -body problem of celestial mechanics all have additive input structure with $g_j(\mathbf{x}_0, \mathbf{x}_j) = G_j(\mathbf{x}_j - \mathbf{x}_0)$ (diffusive coupling – this requires an additive structure on each phase space).

Examples 2.11. (1) Consider the homogeneous 4 identical cell network with dynamics defined by

$$f(x_0; x_1, x_2, x_3) = x_0 x_1 x_2 x_3, \quad x_i \in \mathbb{R}.$$

(We do not specify the connection structure.) The input structure is not additive: there is no natural way to remove (or add) a connection. (2) Consider the homogeneous 4-cell semi-linear feedback network with dynamics defined by

$$f(x_0; x_1, x_2, x_3) = x_0 - x_0^3 + x_0(2x_1 + 3x_3 - 4x_3), \quad x_i \in \mathbb{R}.$$

This system has additive input structure (asymmetric inputs).

The decomposition (2.3) is far from unique. However, if we define

$$\begin{aligned} F_i(\mathbf{x}_i) &= \sum_{s=1}^{k_i} h_{\tau^i(s)}(\mathbf{x}_i, \mathbf{x}_i), \\ g_{\tau^i(s)}(\mathbf{x}_i, \mathbf{x}_{j_i(s)}) &= h_{\tau^i(s)}(\mathbf{x}_i, \mathbf{x}_{j_i(s)}) - h_{\tau^i(s)}(\mathbf{x}_i, \mathbf{x}_i), \end{aligned}$$

then we have

$$(2.4) \quad f_i(\mathbf{x}_i; \mathbf{x}_{j_i(1)}, \dots, \mathbf{x}_{j_i(k_i)}) = F_i(\mathbf{x}_i) + \sum_{s=1}^{k_i} g_{\tau^i(s)}(\mathbf{x}_i, \mathbf{x}_{j_i(s)}),$$

$$(2.5) \quad g_j(\mathbf{x}, \mathbf{x}) = 0, \quad \text{for all } j \in \mathbf{P}, \mathbf{x} \in M.$$

and this decomposition of f_i , subject to (2.5) is unique³. If all the F_i are equal, say to F_0 , then \mathcal{N} will be a heterogeneous network of identical cells with additive input structure and the ‘intrinsic’ dynamics of each cell is given by $\mathbf{x}' = F_0(\mathbf{x})$. This formulation of additive input structure is appropriate for the analysis of synchronization in the network and allows for variable numbers of inputs across the network.

Example 2.12. For example 2.11(2), the g_j will be selected from the maps $E(x, y) = 2x(x - y)$, $F(x, y) = 3x(x - y)$, $G(x, y) = -4x(x - y)$ according to the connection structure. The F_i will depend on the specific connection structure and the resulting ‘intrinsic’ dynamics is artificial and unnatural: dynamics of semi-linear feedback systems does not naturally lead to clustering and synchronization.

The next examples fit well in the additive input model given by (2.4, 2.5).

³Strictly speaking, unique if $j_i : \mathbf{k}_i \rightarrow \ell$ is injective, $i \in \ell$.

Examples 2.13. (1) Suppose

$$f(\theta_0; \theta_1, \theta_2, \theta_3, \dots, \theta_\ell) = \omega + \sum_{i=1}^{\ell} a \sin(\theta_i - \theta_0), \quad \theta_i \in \mathbb{T}, 0 \leq i \leq \ell.$$

This defines the classic Kuramoto phase oscillator model. The intrinsic dynamics is given by $\theta' = \omega$ and we can add or subtract connections without changing the intrinsic dynamics. Similar comments hold if we replace $\sin(\theta_i - \theta_0)$ by any odd trigonometric polynomial in $\theta_i - \theta_0$. We can easily generalize and let the coefficient a depend on i .

(2) Suppose $J_i \subset \ell \setminus \{i\}$, $i \in \ell$, and

$$f_i(\theta_i; \theta_1, \theta_2, \theta_3, \dots, \theta_\ell) = \omega_i + \sum_{j \in J_i} a \sin(\theta_j - \theta_i + \psi_{ij}), \quad \theta_i \in \mathbb{T}, i \in \ell.$$

In this case, adding an input $j \rightarrow i$, will result in a frequency change for A_i from ω_i to $\omega_i + a \sin(\psi_{ij})$. This situation is relevant for power grid models based on a second order differential equation model of phase oscillators (see [30, 19, 20, 61]).

(3) Spiking neural networks typically have additive input structure⁴. Similar remarks hold for pulse-coupled systems [54].

Remark 2.14 (Diffusive coupling). If the phase space M has an additive structure (for example, M is either \mathbb{R}^n or \mathbb{T}^n), then we can write the input maps g_j of (2.4,2.5) as functions of $\mathbf{x}, \mathbf{y} - \mathbf{x}$ (a weak form of diffusive coupling). Specifically, if we define $G_j(\mathbf{x}, \mathbf{z}) = \int_0^1 \frac{d}{dt} g_j(\mathbf{x}, \mathbf{x} + t\mathbf{z}) dt$, then we may rewrite (2.4) in the form

$$(2.6) \quad f_i(\mathbf{x}_i; \mathbf{x}_{j_i(1)}, \dots, \mathbf{x}_{j_i(k_i)}) = F_i(\mathbf{x}_i) + \sum_{s=1}^{k_i} G_{\tau^i(s)}(\mathbf{x}_i, \mathbf{x}_{j_i(s)} - \mathbf{x}_i),$$

where now $G_j(\mathbf{x}, 0) = 0$ for all $j \in \mathbf{P}$, $\mathbf{x} \in M$. We can extend this model to phase spaces with no additive structure using scalar signalling: replace $\mathbf{y} - \mathbf{x}$ by $\xi(\mathbf{y}) - \xi(\mathbf{x}) \in \mathbb{R}^s$.

Suppose we are given a coupled cell system with additive input structure (2.4,2.5) with all cells in the network having identical intrinsic dynamics. Even though the cells in the network may have different numbers of inputs, the minimal synchrony subspace $\Delta(M)$ is always an invariant subspace of M^ℓ and there may exist many synchrony subspaces of M^ℓ . We give examples later in section 5.1.

⁴We do not discuss the issue of spike amplification that can occur in pyramidal neurons in the hypo-campus [31] – this can be modelled using a non-autonomous version of additive input structure that depends on relative timings.

3. TWO CLASSES OF IDENTICAL CELL HOMOGENEOUS COUPLED CELL SYSTEMS THAT SUPPORT HETEROCLINIC NETWORKS

We follow the notational conventions given in the previous section. Up to equivalence [18, 4], there are exactly two connected two identical cell networks with each cell having exactly one input. In figure 4 we show representative networks for each equivalence class.

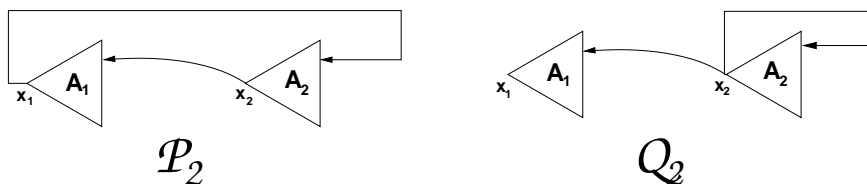

FIGURE 4. The two inequivalent connected two cell networks

Referring to the figure, cells in either network are assumed identical with one input. The phase space of each cell is an unspecified manifold M and state variables are denoted by $\mathbf{x}_1, \mathbf{x}_2$. The only synchrony subspace of either \mathcal{P}_2 or \mathcal{Q}_2 is the minimal synchrony subspace $\Delta_2(M) = \{(\mathbf{x}_1, \mathbf{x}_2) \mid \mathbf{x}_1 = \mathbf{x}_2\}$.

Dynamics on a two identical cell network can never support robust heteroclinic cycles (see [6, §4]).

We will extend the networks \mathcal{P}_2 and \mathcal{Q}_2 to sequences $(\mathcal{P}_n)_{n \geq 2}$ and $(\mathcal{Q}_n)_{n \geq 2}$, where $\mathcal{P}_n, \mathcal{Q}_n$ are identical n -cell homogeneous networks, with each cell having $n - 1$ inputs. Either network \mathcal{P}_n or \mathcal{Q}_n will have $\{A_1, A_j\} = \{\mathbf{x}_1 = \mathbf{x}_j\}$ as a synchrony subspace for $j > 1$. We start with the case $n = 3$ which was previously considered in [6, §5].

3.1. 3-cell networks with two non-trivial synchrony subspaces.

In figure 5, we show the two equivalence classes of the two asymmetric input three cell identical cell networks that admit two non-trivial synchrony subspaces. Observe that \mathcal{P}_3 and \mathcal{Q}_3 are both obtained from \mathcal{P}_2 and \mathcal{Q}_2 by adding an input and one cell which is connected to the original cells the same way (for both networks). Note that we use different arrowheads to distinguish between different input types.

Heteroclinic networks on $\mathcal{P}_3, \mathcal{Q}_3$. The networks $\mathcal{P}_3, \mathcal{Q}_3$ have non-trivial synchrony subspaces $\{A_1, A_2\}$ and $\{A_1, A_3\}$. It is shown in [6, §5] that \mathcal{P}_3 and \mathcal{Q}_3 support robust heteroclinic cycles. More precisely, if we assume each cell has phase space \mathbb{R} (analysis for the phase space \mathbb{T} is similar; higher dimensional dynamics is easier), then we can choose

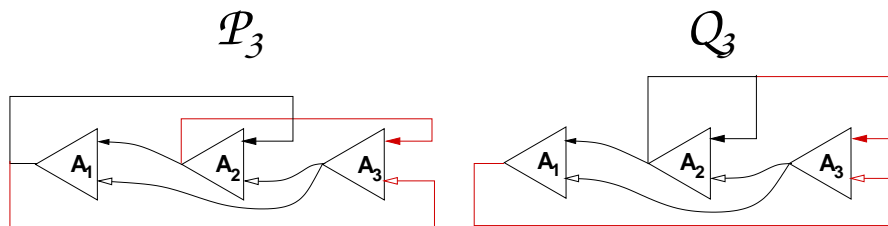

FIGURE 5. The two inequivalent three cell networks with non-trivial synchrony classes $\{A_1, A_2\}$, $\{A_1, A_3\}$.

network dynamics so that there is a simple heteroclinic cycle connecting hyperbolic saddle equilibria \mathbf{p} , \mathbf{q} lying in the trivial synchrony subspace $\Delta_3(\mathbb{R})$, with 1-dimensional connections lying in $\{A_1, A_2\}$ and $\{A_1, A_3\}$. Both equilibria have a 1-dimensional unstable manifold lying in one of the 2-planes $\{A_1, A_2\}$ and $\{A_1, A_3\}$ (but not in $\Delta_3(\mathbb{R})$). We refer to figure 6 for one possible configuration. We have only shown \mathbf{p} , \mathbf{q} connections in one half plane, but it is possible (see [6]) to construct network dynamics so that there are two connections $\mathbf{p} \rightarrow \mathbf{q}$ in $x_1 = x_3$ and two connections $\mathbf{q} \rightarrow \mathbf{p}$ in $x_1 = x_2$. In case cells have 2-dimensional dynamics, Agarwal has constructed an explicit low degree polynomial vector field which realizes all four connections [6, §5].

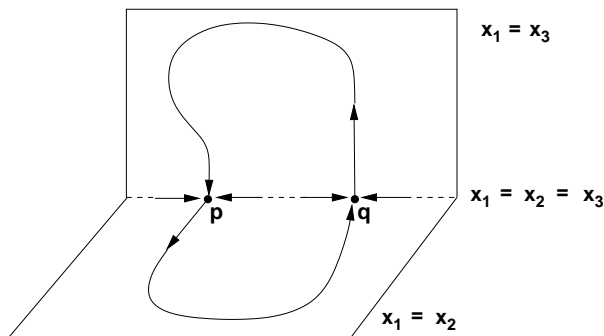

FIGURE 6. A simple heteroclinic cycle connecting \mathbf{p} , \mathbf{q} .

Referring to figure 6, along each connection one of the three cells desynchronizes from the other two (which remain synchronized) and then resynchronizes at the end of the trajectory. For example, A_2 desynchronizes from the pair $\{A_1, A_3\}$ along the connection $\mathbf{q} \rightarrow \mathbf{p}$. This

is precisely the type of desynchronization and resynchronization that occurs along the connections given in our main theorem.

Remark 3.1. Along similar lines to those used in [6], it is not hard to show⁵ that any simple heteroclinic n -cycle can be realized in either of the networks \mathcal{P}_3 and \mathcal{Q}_3 provided that n is even. Indeed, we use the obvious generalization of the setup in figure 6 – see figure 7. If n is odd, it is not possible to realize a simple heteroclinic n -cycle if we assume 1-dimensional node dynamics. If node dynamics are 2-dimensional, realization is straightforward.

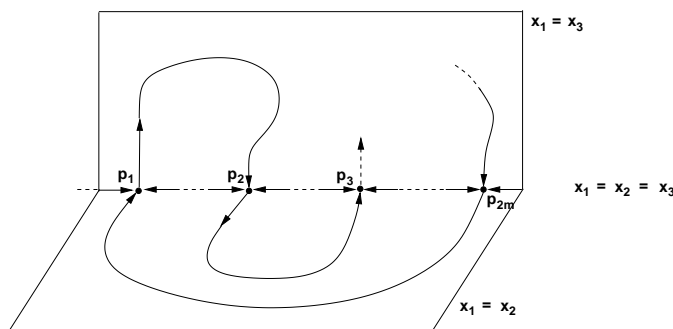

FIGURE 7. A simple heteroclinic cycle connecting $2m$ nodes: $\mathbf{p}_1, \dots, \mathbf{p}_{2m}$.

In general, the graph of any heteroclinic network, with out- and in-degrees at most two for each node, can easily be realized as a simple heteroclinic network in either \mathcal{P}_3 or \mathcal{Q}_3 provided that we allow cell dynamics to be 2-dimensional. In many (possibly all) cases we can realize using 1-dimensional cell dynamics (we have not found any counterexamples to realization by 1-dimensional node dynamics for graphs with at most 6 nodes).

Example 3.2. Both graphs shown in figure 8 can be realized using 1-dimensional cell dynamics as a simple heteroclinic network. To see why this is so, observe that for realization as a heteroclinic network, the connections between equilibria lie either in $x_1 = x_2$ or $x_1 = x_3$. Once we have decided which subspace $W^u(p)$ is contained in, all the other subspaces are determined. Thus in figure 8(a), $W^u(p), W^u(r)$ are contained in one invariant subspace, say $x_1 = x_2$, the remaining connections lie $x_1 = x_3$ (broken lines). If we apply the same argument to figure 8(b), $W^u(s), W^u(p)$ lie in the same subspace and so must intersect. However, if we place s between q and r , $W^u(s), W^u(p)$ no

⁵We review the methods used in [6] when we address the general case.

longer have to intersect and we can realize the graph as a heteroclinic network. Similar arguments work for every 4 node network.

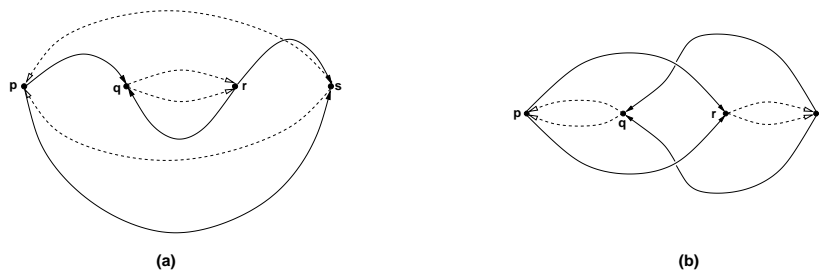

FIGURE 8. Graphs with 4 nodes that can be realized in $\mathcal{P}_3, \mathcal{Q}_3$ as simple heteroclinic networks connecting 4 cells with 1-dimensional cell dynamics.

3.2. The sequences $(\mathcal{P}_n)_{n \geq 3}, (\mathcal{Q}_n)_{n \geq 3}$.

Proposition 3.3. *We may construct a sequence $(\mathcal{P}_n)_{n \geq 2}$ of coupled cell networks uniquely characterized by the following properties:*

- (1) \mathcal{P}_n consists of n identical cells A_1, \dots, A_n , each with $n - 1$ (asymmetric) inputs.
- (2) For $2 \leq i \leq n$, $\{A_1, A_i\}$ is a synchrony class of \mathcal{P}_n .
- (3) For $n \geq 2$, \mathcal{P}_{n+1} is built from \mathcal{P}_n by taking a new cell A_{n+1} with n -input types i_1, \dots, i_n and then
 - (a) Connecting the first n cells A_1, \dots, A_n according to the pattern of \mathcal{P}_n using only the input types i_1, \dots, i_{n-1} .
 - (b) Connecting the output of cell A_{n+1} to the i_n inputs of A_1, \dots, A_n .
 - (c) Connecting the output of A_j to the i_{j-1} -input of A_{n+1} , $1 \leq j \leq n$ where our convention is that the output of A_1 goes to the i_n -input of A_{n+1} .
- (4) \mathcal{P}_2 is the coupled cell network of figure 4.

Proof. By (3b), the cells A_1, \dots, A_n of \mathcal{P}_{n+1} see the same inputs from A_{n+1} . It is immediate from (3a) and proposition 2.7 that if \mathcal{P}_n has synchrony classes $\{A_1, A_i\}$, $2 \leq i \leq n$, the same will be true for \mathcal{P}_{n+1} . Hence, by (3c) and proposition 2.7, $\{A_1, A_{n+1}\}$ is a synchrony class for \mathcal{P}_{n+1} . The proof is immediate by the obvious induction. \square

Remark 3.4. An easy consequence of proposition 2.7 is that $\{A_i, A_j\}$ is not a synchrony class of \mathcal{P}_n if $i, j \geq 2$.

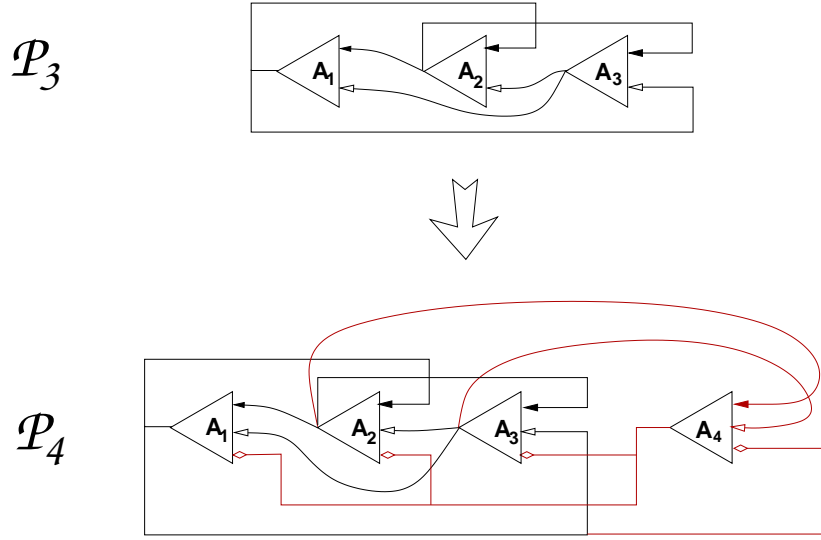

FIGURE 9. Constructing \mathcal{P}_4 from \mathcal{P}_3 .

Example 3.5. In figure 9 we illustrate the construction of \mathcal{P}_4 used in the proof of proposition 3.3.

We have an analogous result to proposition 3.3 but starting with the network \mathcal{Q}_2 . We omit the proof.

Proposition 3.6. *We may construct a sequence $(\mathcal{Q}_n)_{n \geq 2}$ of coupled cell networks uniquely characterized by the following properties:*

- (1) \mathcal{Q}_n consists of n identical cells A_1, \dots, A_n , each with $n - 1$ (asymmetric) inputs.
- (2) For $2 \leq i \leq n$, $\{A_1, A_i\}$ is a synchrony class of \mathcal{Q}_n .
- (3) For $n \geq 2$, \mathcal{Q}_{n+1} is built from \mathcal{Q}_n by taking a new cell A_{n+1} with n -input types i_1, \dots, i_n and then
 - (a) Connecting the first n cells A_1, \dots, A_n according to the pattern of \mathcal{Q}_n but using only the input types i_1, \dots, i_{n-1} .
 - (b) Connecting the output of cell A_{n+1} to the i_n inputs of A_1, \dots, A_n .
 - (c) Connecting the output of A_1 to the i_n input of A_{n+1} , and the output of A_2 to the i_1 -input of A_{n+1} .
 - (d) Connecting the output of A_j to the i_j input of A_{n+1} , $3 \leq j \leq n$.
- (4) \mathcal{Q}_2 is the coupled cell network \mathcal{Q}_2 of figure 5.

4. REALIZATION OF HETEROCLINIC NETWORKS IN \mathcal{P}_n AND \mathcal{Q}_n

Let $\Gamma = \Gamma(N, E)$ be a graph with $N \geq 2$ vertices $\mathbf{v}_1, \dots, \mathbf{v}_N$ and E edges joining vertices (as usual, we assume conditions $(C1, C2)$ hold).

We show that there exists $n \leq E + 1$ such that Γ can be realized as a *robust* heteroclinic network for a coupled cell system with network architecture either \mathcal{P}_n or \mathcal{Q}_n . The representation will be implemented in an interesting way that reflects the possibilities of synchronization in \mathcal{P}_n and \mathcal{Q}_n (this will require $n = E + 1$). In more detail, we prove our result in the hardest case where cell dynamics is 1-dimensional and dynamics is C^∞ . Each vertex $\mathbf{v}_i \in \Gamma$ will correspond to a fully synchronized hyperbolic saddle $\mathbf{p}_i \in \Delta_n(\mathbb{R})$ and edges $\mathbf{v}_j \rightarrow \mathbf{v}_i$ will correspond to connecting orbits $\mathbf{p}_j \rightarrow \mathbf{p}_i$ lying in a 2-dimensional invariant (synchrony) subspace. The robustness of the realization will follow in the standard way from the hyperbolicity of nodes and the (trivial) transversality of stable and unstable manifolds within invariant subspaces. Finally, the realization will reflect synchronization and desynchronization patterns in \mathcal{P}_n and \mathcal{Q}_n . To explain this, we need new definitions and notation.

Unless stated to the contrary, we henceforth assume that each cell has phase space \mathbb{R} – the extension to the case where the phase space is a general connected manifold is routine. For \mathcal{P}_n and \mathcal{Q}_n , let $P_2, \dots, P_n \subset \mathbb{R}^n$ be the 2-planes defined by

$$\begin{aligned} P_2 &= \{(x_1, x_2, x_1, \dots, x_1) \mid (x_1, x_2) \in \mathbb{R}^2\} = \cap_{i \neq 2} \{A_1, A_i\} \\ P_3 &= \{(x_1, x_1, x_3, x_1, \dots, x_1) \mid (x_1, x_3) \in \mathbb{R}^2\} = \cap_{i \neq 3} \{A_1, A_i\} \\ \dots &= \dots\dots\dots \\ P_n &= \{(x_1, x_1, x_1, x_1, \dots, x_n) \mid (x_1, x_n) \in \mathbb{R}^2\} = \cap_{i \neq n} \{A_1, A_i\}. \end{aligned}$$

As the planes P_j are synchrony subspaces, they are invariant by network dynamics.

Definition 4.1. Let \mathcal{N} be a coupled cell system with network architecture either \mathcal{P}_n or \mathcal{Q}_n . Denote the cells of \mathcal{N} by A_1, \dots, A_n . Assume networks dynamics given by the vector field X .

- (1) Let $k \geq 2$. A connecting trajectory $\mathbf{p} \rightarrow \mathbf{q}$ between hyperbolic equilibria $\mathbf{p}, \mathbf{q} \in \Delta(\mathbb{R})$ is *k-simple* if the cells $\{A_j \mid j \in \mathbf{n}, j \neq k\}$ are synchronized along the connection and A_k is desynchronized from $\{A_j \mid j \in \mathbf{n}, j \neq k\}$. If the connection is *k-simple*, set $\mathfrak{s}(\mathbf{p} \rightarrow \mathbf{q}) = k$.
- (2) A heteroclinic network for X is *well-adapted* if all connections are simple.

- (3) The representation of a connected graph as a well-adapted heteroclinic network in \mathcal{N} is *strict* if given connections γ, ρ then $\mathfrak{s}(\gamma) = \mathfrak{s}(\rho)$ if and only if $\gamma = \rho$.

Remarks 4.2. (1) The k -simplicity of a connection $\mathbf{p} \rightarrow \mathbf{q}$ is equivalent to requiring that the connection lies in the 2-plane P_k .

(2) It is convenient to weaken our definition of strictness – at least for the case of 1-dimensional cell dynamics – and say that the representation of a connected graph as a well-adapted heteroclinic network in \mathcal{N} is strict if (a) there are at most two connections in each P_k , and (b) they connect the same nodes in the same direction.

Examples 4.3. (1) The heteroclinic cycle of figure 6 is well-adapted and strict.

(2) The heteroclinic cycle of figure 7 is well-adapted but not strict (unless $m = 1$).

(3) Realizations of the graphs of figure 8 as heteroclinic networks in \mathcal{P}_3 are well-adapted but never strict.

Theorem 4.4. *Let $\Gamma = \Gamma(N, E)$ be a graph which satisfies conditions (C1, C2). Then we can realize Γ as the graph of a robust heteroclinic network Σ in \mathcal{P}_n , where $n = E + 1$ and Σ is well-adapted and strict.*

We may similarly represent Γ as the graph of a heteroclinic network Σ in \mathcal{Q}_n , $n = E + 1$.

In either case we may require the network vector field to be smooth (C^∞). The heteroclinic network Σ will persist under sufficiently small C^1 perturbations by C^r network vector fields, $r \geq 1$.

Before giving the detailed proof of theorem 4.4, we summarize the main steps. We assume throughout that $n = E + 1$. In section 4.3, we construct N affine linear vector fields with hyperbolic equilibria $\mathbf{Z} = \{\mathbf{p}_1, \dots, \mathbf{p}_N\} \subset \Delta_n(\mathbb{R})$ with preassigned stabilities. We patch these vector fields together to define a smooth map f on a neighbourhood D of $\Delta(\mathbb{R})$ in \mathbb{R}^n so that the set of equilibria for the associated network vector field contains \mathbf{Z} . Working on the invariant subspaces P_j , we next choose for each $j \in \mathbf{n}$, $j > 1$, a connection between a pair of equilibria in \mathbf{Z} and then smoothly extend f from D to this set of connections. Finally, we extend f to \mathbb{R}^n . The tricky step is defining f so the network vector field has the right connections. As each connection will lie in a unique 2-dimensional synchrony subspace, there will not be a problem of possible intersection of connections (unlike in example 3.2). The difficulty comes from the constraints that the network architecture imposes on the restriction F^j of the network vector field to the invariant subspace P_j : the vector fields F_j all have the same

‘vertical’ components. We include a few details needed for the proof of proposition 3.6.

4.1. Linearization at synchronized equilibria: architecture \mathcal{P}_n .

We continue to assume 1-dimensional node dynamics (results are similar for k -dimensional node dynamics with constants α, β_i replaced by general $k \times k$ real matrices A, B_i).

Evolution of the nodes is given by

$$\begin{aligned} x'_1 &= f(x_1; x_2, x_3, \dots, x_n) \\ \dots &= \dots\dots\dots \\ x'_n &= f(x_n; x_2, \dots, x_{n-1}, x_1), \end{aligned}$$

where $f : \mathbb{R} \times \mathbb{R}^{n-1} \rightarrow \mathbb{R}$ determines cell dynamics. Denote the associated vector field on \mathbb{R}^n defining network dynamics by F . Suppose that $\mathbf{p} \in \Delta(\mathbb{R})$ is an equilibrium of the system. Define

$$\alpha = \frac{\partial f}{\partial x_1}(\mathbf{p}), \beta_2 = \frac{\partial f}{\partial x_2}(\mathbf{p}), \dots, \beta_n = \frac{\partial f}{\partial x_n}(\mathbf{p}).$$

(Here we regard $f = f(x_1; x_2, \dots, x_n)$).

Lemma 4.5. *The rows R_1, \dots, R_n of the Jacobian matrix $J(F)(\mathbf{p})$ of F at \mathbf{p} are given by*

$$R_j = [\beta_2, \dots, \beta_j, \alpha, \beta_{j+1}, \dots, \beta_n], \quad j \in \mathbf{n}.$$

The eigenvalues of $J(F)(\mathbf{p})$ are

$$\alpha + \sum_{i=2}^n \beta_i, \alpha - \beta_2, \dots, \alpha - \beta_n.$$

The eigenvalue $\alpha + \sum_{i=2}^n \beta_i$ has eigenspace the minimal synchrony subspace $\Delta_n(\mathbb{R})$. The eigenspace associated to $\alpha - \beta_k$ lies in the 2-dimensional synchrony subspace $P_k, k \geq 2$.

Proof. Routine elementary computations using row and column operations to identify eigenvalues. □

Remark 4.6. Each synchrony subspace P_k is invariant by the Jacobian matrix $J(F)(\mathbf{p})$ and $J(F)(\mathbf{p})|_{P_k}$ has eigenvalues $\alpha + \sum_{i=2}^n \beta_i$ and $\alpha - \beta_k$ ($\alpha + \sum_{i=2}^n \beta_i$ is an eigenvalue for each $J(F)(\mathbf{p})|_{P_k}$ since $\Delta_n(\mathbb{R}) \subset P_k$ for all $k \geq 2$).

4.2. Linearization at synchronized equilibria: architecture \mathcal{Q}_n .

As above, let F denote the vector field defining network dynamics on \mathcal{Q}_n and assume $\mathbf{p} \in \Delta(\mathbb{R})$ is an equilibrium of the system.

Lemma 4.7. *The eigenvalues of the Jacobian matrix $J(F)(\mathbf{p})$ are*

$$\alpha + \sum_{i=2}^n \beta_i, \alpha, \alpha - \beta_3, \dots, \alpha - \beta_n.$$

The eigenvalue $\alpha + \sum_{i=2}^n \beta_i$ has eigenspace $\Delta(\mathbb{R})$. The eigenspace associated to α lies in the synchrony subspace P_2 and the eigenspace associated to $\alpha - \beta_k$ lies in the synchrony subspace P_k , $k = 3, \dots, n$.

4.3. Constructing network compatible vector fields near $\Delta(\mathbb{R})$.

Our goal in this section is to show that given $n \geq 3$, we can choose (smooth) network dynamics on \mathcal{P}_n with a pre-specified set of equilibria on $\Delta(\mathbb{R})$ and pre-specified Jacobian matrices at these equilibria (consistent with the matrix structure given by lemma 4.5).

Lemma 4.8. *Let $N \geq 2$. Choose distinct points $\mathbf{p}_\ell \in \Delta(\mathbb{R})$, $\ell \in \mathbf{N}$. Given real constants $\alpha^\ell, \beta_j^\ell$, $\ell \in \mathbf{N}$, $2 \leq j \leq n$, define the $n \times n$ matrices \mathbf{J}_ℓ by requiring that \mathbf{J}_ℓ has rows R_j^ℓ given by*

$$R_j^\ell = [\beta_2^\ell, \dots, \beta_j^\ell, \alpha^\ell, \beta_{j+1}^\ell, \dots, \beta_n^\ell], \quad j \in \mathbf{n}.$$

Then there exists a smooth (C^∞) $f : \mathbb{R} \times \mathbb{R}^{n-1} \rightarrow \mathbb{R}$ such that the associated network vector field F on \mathcal{P}_n has the following properties:

- (1) $\mathbf{p}_\ell \in \Delta(\mathbb{R})$ is an equilibrium of F , $\ell \in \mathbf{N}$.
- (2) F is affine linear in a neighbourhood of each \mathbf{p}_ℓ , and

$$J(F)(\mathbf{p}_\ell) = \mathbf{J}_\ell, \quad \ell \in \mathbf{N}$$

Proof. Let $g, h_1, \dots, h_n : \mathbb{R} \rightarrow \mathbb{R}$ be C^∞ . Let $\pi : \mathbb{R}^n \rightarrow \Delta(\mathbb{R})$ be the orthogonal projection on the diagonal. Define the smooth map $f : \mathbb{R} \times \mathbb{R}^{n-1} \rightarrow \mathbb{R}$ by

$$f(x_1; x_2, \dots, x_n) = g(\pi(x_1, \dots, x_n)) + \sum_{i=1}^n h_i(\pi(x_1, \dots, x_n))x_i$$

Observe that

$$f(x) = g(x) + x \sum_{i=1}^n h_i(x), \quad x \in \Delta(\mathbb{R}) \approx \mathbb{R}.$$

Choose the maps h_i so that (a) each h_i is constant near \mathbf{p}_ℓ , $\ell \in \mathbf{N}$, and (b) $h_1(\mathbf{p}_\ell) = \alpha^\ell$, $h_i(\mathbf{p}_\ell) = \beta_i^\ell$, $i > 1$. Now choose g , constant near each \mathbf{p}_ℓ , so that $f(\mathbf{p}_\ell) = 0$ for $\ell \in \mathbf{N}$. \square

4.4. Compatibility conditions for network vector fields. We consider the case where cells have one dimensional phase space \mathbb{R} . The case where the phase space is of dimension at least two is easier and omitted (see [6, §5]). Recall that dynamics on \mathcal{P}_n is given by the system of differential equations

$$\begin{aligned} x'_1 &= f(x_1; x_2, x_3, \dots, x_n) \\ x'_2 &= f(x_2; x_1, x_3, \dots, x_n) \\ \dots &= \dots\dots\dots \\ x'_n &= f(x_n; x_2, \dots, x_{n-1}, x_1), \end{aligned}$$

where $f : \mathbb{R} \times \mathbb{R}^{n-1} \rightarrow \mathbb{R}$ is smooth. Restricted to the flow invariant 2-plane P_j , dynamics is given by the system

$$(4.7) \quad x'_1 = f(x_1; x_1, \dots, x_1, x_j, x_1, \dots, x_1)$$

$$(4.8) \quad x'_j = f(x_j; x_1, \dots, x_1, x_1, x_1, \dots, x_1).$$

Denote the vector field defined by (4.7, 4.8) on P_j by $F^j = (H_j, V_j)$, $j \geq 2$. We need to choose f so that the vector fields F^j have the properties necessary for the heteroclinic network. Already we have constructed f so that on a neighbourhood D of $\Delta(\mathbb{R})$ in \mathbb{R}^n , we have the required equilibria with assigned stabilities. Observe that outside of a neighbourhood $D \subset \mathbb{R}^2$ of the diagonals $x_i = x_j$, $j > 1$, the x_1 -component H_j of the vector fields on P_j can be chosen freely. On the other hand, the vertical components must satisfy

$$(4.9) \quad V_i(u, v) = V_j(u, v) (= f(v; u, \dots, u)), \quad (u, v) \in \mathbb{R}^2, \quad \text{all } i, j \in \mathbf{n}.$$

Set $V(u, v) = f(v; u, \dots, u)$, $(u, v) \in \mathbb{R}^2$. Outside of a neighbourhood D of $\Delta(\mathbb{R})$, we can choose V freely and, in particular, not affect choices made for H_1, \dots, H_n .

4.5. Proof of Theorem 4.4. Suppose Γ has N vertices $\mathbf{v}_1, \dots, \mathbf{v}_N$ and E edges e_1, \dots, e_E . Take $n = E + 1$ and choose distinct points $\mathbf{p}_i \in \Delta(\mathbb{R})$, $i \in \mathbf{N}$. If e_i connects \mathbf{v}_s to \mathbf{v}_r , set $S(e_i) = s$, $T(e_i) = r$ and note that by (C1), $s \neq r$. For each $\ell \in \mathbf{N}$, let $O(\ell) = \{j \mid S(e_j) = \ell\}$ and set $d_\ell = |O(\ell)|$ (d_ℓ is the out-degree d_ℓ^{out}). By conditions (C1,C2), $1 \leq d_\ell < E$. Set $d_0 = 2$ and define a partition of $\{2, \dots, E + 1\}$ by

$$\begin{aligned} E_1 &= \{d_0, d_0 + 1, \dots, d_1 + d_0 - 1\}, \\ E_2 &= \{d_0 + d_1, \dots, d_1 + d_2 + d_0 - 1\}, \\ \dots &= \dots\dots\dots \\ E_N &= \left\{ \sum_{i=0}^{N-1} d_i, \dots, \sum_{i=0}^N d_i - 1 = E + 1 \right\}. \end{aligned}$$

Relabelling the edges e_i we may suppose that

- (1) If $S(e_i) = s$, then $i \in E_s$.
- (2) if $i < j \in E_s$ then $T(e_i) \leq T(e_j)$.

For $\ell \in \mathbf{N}$, choose $\alpha^\ell, \beta_2^\ell, \dots, \beta_n^\ell \in \mathbb{R}$ such that

$$\begin{aligned} \alpha^\ell - \beta_j^\ell &< 0, \text{ if } j \notin E_\ell \\ \alpha^\ell - \beta_j^\ell &> 0, \text{ if } j \in E_\ell, \\ \alpha^\ell + \sum_{j=2}^N \beta_j^\ell &< 0. \end{aligned}$$

Apply lemma 4.8 to construct f which has the specified Jacobian matrices \mathbf{J}_ℓ at each equilibrium \mathbf{p}_ℓ , $\ell \in \mathbf{N}$. Perturbing the $\alpha^\ell, \beta_j^\ell$ if necessary, we may further assume that the set of 1-dimensional eigenspaces at each equilibrium are distinct when viewed as subsets of \mathbb{R}^2 (identify each P_j with \mathbb{R}^2).

Let d denote the Euclidean distance on \mathbb{R}^n . Given $\delta > 0$, set $D = \{\mathbf{x} \in \mathbb{R}^n \mid d(\mathbf{x}, \Delta(\mathbb{R})) \leq \delta\}$. Let $\pi : D \rightarrow \Delta(\mathbb{R})$ denote the associated tubular neighbourhood of $\Delta(\mathbb{R})$ (π will be the restriction to D of orthogonal projection on $\Delta(\mathbb{R})$). Choose $\delta > 0$ sufficiently small so that for each $\ell \in \mathbf{N}$, we can choose an interval neighbourhood U_ℓ of \mathbf{p}_ℓ in $\Delta(\mathbb{R})$ such that the network vector field F associated to f is linear on $\pi^{-1}(U_\ell)$. In particular, the trajectories along the 1-dimensional eigenspaces (in the stable and unstable manifolds at \mathbf{p}_ℓ) will intersect ∂D transversally.

Thus far we have defined f and the network vector field F on D . It remains to extend f to \mathbb{R}^n to obtain the desired heteroclinic connection structure. We do this by first extending F smoothly to the set of connecting trajectories and then extending to the network phase space.

Given $i \in E_j$, make a smooth connection γ_i in P_i from \mathbf{p}_j to \mathbf{p}_t , where $t = T(\gamma_i)$. We do this so that $\gamma_i \cap D$ is contained in the eigenspace of $\alpha^\ell - \beta_i^\ell$ and is a trajectory of $F|_D$ (note lemma 4.5 and that $\alpha^\ell - \beta_i^\ell > 0$). Taking the projection into \mathbb{R}^2 , it is clear that there may be multiple intersections between different γ_i . By perturbing the constants $\alpha^\ell, \beta_i^\ell$, we may adjust the trajectories in $P_j \cap D$ so that the trajectories in $P_j \cap D$ are all disjoint when projected into \mathbb{R}^2 . Next observe that if we have connections γ_i from $\mathbf{p}_u \rightarrow \mathbf{p}_v$ and γ_r from $\mathbf{p}_a \rightarrow \mathbf{p}_b$ then if either $(\mathbf{p}_u, \mathbf{p}_v) \supset [\mathbf{p}_a, \mathbf{p}_b]$ or $(\mathbf{p}_a, \mathbf{p}_b) \supset [\mathbf{p}_u, \mathbf{p}_v]$, then we can always smoothly deform the connections outside of D so that their projections in \mathbb{R}^2 do not intersect. In the remaining case, we can deform the connections so that there is at most one intersection which we can assume is transverse (within \mathbb{R}^2). We may further require that the intersection points are

distinct (within \mathbb{R}^2). A formal proof is based on the obvious inductive argument over $i \in \mathbf{E}$.

Denote the points of intersection of connections in \mathbb{R}^2 by z_1, \dots, z_k . Choose $\varepsilon > 0$, so that the closed disc neighbourhoods $\{D_\varepsilon(z_i) \mid i \in \mathbf{k}\}$ are mutually disjoint: $D_\varepsilon(z_i) \cap D_\varepsilon(z_j) = \emptyset$ if $i \neq j$. There are two cases we need to consider. Referring to figure 10(a), observe that at the intersection point z_i the vertical components of γ'_a and γ'_b point in the same direction. Reparametrizing γ_a we can assume the vertical components are identical (alternatively, multiply the vector field $\gamma'_a(t)$ by an appropriate strictly positive smooth function equal to 1 outside $D_\varepsilon(z_i)$).

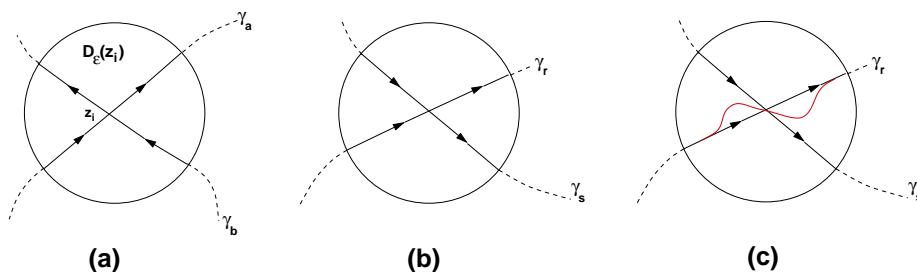

FIGURE 10. Intersections of connecting trajectories

In the second case, where the vertical components point in opposite directions, we deform one of the curves to achieve the situation of (a) – see figure 10(c). Note that this case handles the situation where one of the curves has zero vertical component at the intersection. All of these changes are supported inside the family of discs $D_\varepsilon(z_i)$. Now extend the vector field F as a network vector field from D to $D \cup_{i \in \mathbf{E}} \gamma_i(\mathbb{R})$ by defining $F(\gamma_i(t)) = \gamma'_i(t)$. This defines f as a smooth map on a closed subset of \mathbb{R}^n . Now smoothly extend f to all of \mathbb{R}^n using either the Whitney extension theorem or a simple partition of unity argument.

Finally, we remark that the heteroclinic network we have constructed is robust under C^1 perturbations of network vector fields. This is a standard argument: equilibria are hyperbolic and, within the 2-dimensional invariant subspace, we have a connection from a saddle point to a sink which is not destroyed under perturbation by network vector fields. \square

We conclude this section with two examples and a remark about the effect of removing the requirement of strictness.

Examples 4.9. (1) The heteroclinic cycle of figure 7 can be realized in \mathcal{P}_n as a strict network provided $n \geq 2m + 1$. The same is true if we

require pairs of connections from $\mathbf{p}_i \rightarrow \mathbf{p}_{i+1}$ (note remarks 4.2(2)).

(2) Suppose $\Gamma = \Gamma(2, E)$ satisfies conditions (C1,C2). Then we can realize Γ as a strict heteroclinic network Σ in \mathcal{P}_n for $n \geq E + 1$. In this case we can do better if we pair connections between nodes and use remarks 4.2(2)). For example, if E is even and there are $2k$ connections from $\mathbf{v}_1 \rightarrow \mathbf{v}_2$, we can realize Γ by a strict heteroclinic network Σ in \mathcal{P}_n for $n \geq \frac{E}{2} + 1$.

Remark 4.10. If we drop the requirement of strictness, we can realize graphs as robust heteroclinic networks in much smaller coupled cell networks. We have already indicated that the heteroclinic cycle of figure 7 can be realized in \mathcal{P}_3 as a well-adapted network for all $m \geq 2$. Similarly, heteroclinic cycles with an odd number of nodes can always be realized as well-adapted heteroclinic networks in \mathcal{P}_4 . The graph $\Gamma = \Gamma(2, E)$ of examples 4.9 can be represented as a well-adapted heteroclinic network in \mathcal{P}_5 . Briefly, suppose hyperbolic equilibria $\mathbf{p}, \mathbf{q} \in \Delta(\mathbb{R})$. Assume (a) \mathbf{p}, \mathbf{q} are both sinks for dynamics restricted to $\Delta(\mathbb{R})$, (b) the unstable manifolds of \mathbf{p}, \mathbf{q} are 2-dimensional and $W^u(\mathbf{p}) \subset P_2 \times P_3$, $W^u(\mathbf{q}) \subset P_4 \times P_5$, (c) $W^u(\mathbf{p})$ intersects $W^s(\mathbf{q})$ transversally in n connections, and $W^u(\mathbf{q})$ intersects $W^s(\mathbf{p})$ transversally in m connections, where $n + m = E$ and n gives the number of connections in Γ from $\mathbf{p} \rightarrow \mathbf{q}$.

5. ADDITIVE INPUT STRUCTURE

In the previous section we made no assumptions about cell dynamics beyond assuming that dynamics on a cell with k inputs and state space M was determined by a smooth map $f : M \times M^k \rightarrow TM$. In applications it is often important to assume an additive input structure that allows variation in the number of inputs between cells.

Proposition 5.1. *We may require additive input structure in theorem 4.4. Specifically, given a graph $\Gamma(N, E)$ satisfying (C1,C2), there exist smooth functions $F_0 : \mathbb{R} \rightarrow \mathbb{R}$ and $g_2, \dots, g_{E+1} : \mathbb{R}^2 \rightarrow \mathbb{R}$ such that the requirements of theorem 4.4 are satisfied if network dynamics are defined by*

$$(5.10) \quad f(x_1; x_2, \dots, x_{E+1}) = F_0(x_1) + \sum_{j=2}^{E+1} g_j(x_1, x_j),$$

where $g_j(x, x) = 0$, all $x \in \mathbb{R}$, $2 \leq j \leq E + 1$.

Proof. By theorem 4.4, there exists a smooth map $f : \mathbb{R} \times \mathbb{R}^E \rightarrow \mathbb{R}$ which realizes Γ as a heteroclinic network in \mathcal{P}_n , where $n = E + 1$. We have to

prove that f can be chosen in the desired form. Observe that if (5.10) holds then

$$(5.11) \quad F_0(x) = f(x; x, \dots, x), \quad x \in \mathbb{R}.$$

As usual we identify the 2-planes P_j with \mathbb{R}^2 and take coordinates (x_1, x_j) on P_j . Denote the network vector field associated to f by $F : \mathbb{R}^n \rightarrow \mathbb{R}^n$. For $j = 2, \dots, E + 1$, define $(H_j, V_j) = F|_{P_j}$.

We have

$$\begin{aligned} H_2(x_1, x_2) &= f(x_1; x_2, x_1, x_1, \dots, x_1) \\ H_3(x_1, x_3) &= f(x_1; x_1, x_3, x_1, \dots, x_1) \\ &\dots = \dots \\ H_{E+1}(x_1, x_{E+1}) &= f(x_1; x_1, x_1, \dots, x_{E+1}) \\ V_j(x_1, x_j) &= f(x_j; x_1, \dots, x_1), \quad 2 \leq j \leq E + 1. \end{aligned}$$

Viewed as functions on \mathbb{R}^2 , the $H_j : \mathbb{R}^2 \rightarrow \mathbb{R}$ can be chosen freely, subject only to $H_j(x, x) = F_0(x)$, for all $x \in \mathbb{R}^2$, $2 \leq j \leq n$. On the other hand, we have $V_2 = \dots = V_{E+1}$ and $V_j(x, x) = F_0(x)$, for all $x \in \mathbb{R}^2$, $2 \leq j \leq n$. Set $V(x, y) = V_2(x, y) = \dots = V_{E+1}(x, y)$. Assume then that H_2, \dots, H_n, V, F_0 are given. Substituting in (5.10), we must find smooth functions g_2, \dots, g_{E+1} so that

$$\begin{aligned} H_2(x, y) &= F_0(x) + g_2(x, y) \\ H_3(x, y) &= F_0(x) + g_3(x, y) \\ &\dots = \dots \\ H_{E+1}(x, y) &= F_0(x) + g_{E+1}(x, y) \\ V(x, y) &= F_0(y) + \sum_{j=2}^{E+1} g_j(y, x). \end{aligned}$$

Solve the first E equations uniquely for the unknowns g_2, \dots, g_{E+1} : $g_j(x, y) = H_j(x, y) - F_0(x)$, $0 \leq j \leq 2$. Without further work we cannot satisfy the final equation for the vertical component since this, together with (5.10), implies the relation

$$(5.12) \quad f(x; y^E) + (E - 1)f(x; x^E) = \sum_{j=0}^{E-1} f(x; x^j, y, x^{E-j-1}),$$

where x^s is abbreviated notation for s copies of x , $0 \leq s \leq E$. Obviously (5.12) fails for general maps $f : \mathbb{R} \times \mathbb{R}^{n-1} \rightarrow \mathbb{R}$. However, since

the common vertical components satisfy

$$(5.13) \quad V(x, y) = F_0(y) + \sum_{j=2}^{E+1} g_j(y, x), \quad (x, y) \in \mathbb{R}^2.$$

it follows that if we insist the connection in P_j is always made by a trajectory in $\Delta_j^+ = \{(x_1, x_j) \mid x_j > x_1\}$ then the vertical component $V_j(x_1, x_j) = F_0(x_j) + \sum_{j=2}^{E+1} g_j(x_j, x_1)$ depends only on the values of g_2, \dots, g_{E+1} in $\Delta_j^- = \{(x_1, x_j) \mid x_j < x_1\}$ which are not used in the connection construction for the horizontal vector fields. We can modify the original proof of theorem 4.4 in the following way. We start as before by constructing a vector field giving the required fully synchronous equilibria and stabilities on a tubular neighbourhood of the diagonal – there is no difficulty with the additive input structure on D . Let $\pi : \mathbb{R}^2 \rightarrow \mathbb{R}^2$ denote the reflection in the diagonal: $\pi(x, y) = (y, x)$. Choose connections $\gamma_j \subset \Delta_j^+$ so that the curves $\pi(\gamma_j)$ intersect transversally in at most one point. Just as in the proof of theorem 4.4 we do a local deformation of H_j (in Δ_j^-) so that the vertical components match at points of intersection. \square

Remark 5.2. In the proof of proposition 5.1, we assumed connections lay in $\Delta_j^+ = \{(x_1, x_j) \mid x_j > x_1\}$, $2 \leq j \leq E + 1$. It is not hard to extend the proof to allow for connections in Δ_j^\pm . In particular, we can require both additive input structure and pairs of connections in each P_k between equilibria (see remarks 4.2(2)).

5.1. Heterogeneous Networks. Our results can be applied to heterogeneous networks consisting of identical cells with additive input structure. We give an example to illustrate the general idea.

Example 5.3. In figure 11 we show a 4 cell network with additive input structure. We assume there are 3 input types and identical dynamics on the uncoupled cells. Cells 1, 2 and 3 have three inputs; cell 4 has two inputs (of types 2 and 3). The network has synchrony subspaces $\{A_1, A_2\}$, $\{A_1, A_3\}$, $\{A_1, A_2, A_3\}$, $\{A_1, A_2, A_4\}$, and $\{A_1, A_2, A_3, A_4\}$.

It is straightforward to show that we can choose 1 dimensional cell dynamics and an additive input structure so that there is a robust heteroclinic cycle joining equilibria $\mathbf{p}, \mathbf{q} \in \{(x_1, \dots, x_4) \mid x_1 = x_2 = x_3\}$. Indeed, the verification is simpler than in proposition 5.1 as we can ensure the projections into \mathbb{R}^3 of the connecting trajectories between \mathbf{p}, \mathbf{q} do not intersect. It is also straightforward to construct a robust simple heteroclinic cycle joining equilibria $\mathbf{p}, \mathbf{q} \in \Delta_4(\mathbb{R})$, with connections in the 2-dimensional synchrony subspaces $\{A_1, A_2, A_3\}$ and $\{A_1, A_2, A_4\}$.

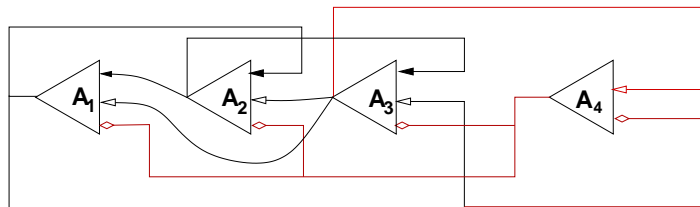

FIGURE 11. A 4 cell heterogenous network with additive input structure.

Here we have a heteroclinic cycle between cells with different numbers of inputs.

Remark 5.4. The previous example shows that a heterogeneous network \mathcal{N} consisting of identical cells with additive input structure may support robust heteroclinic networks. Of course, one can build complex heterogeneous networks \mathcal{N} which contain a subnetwork \mathcal{N}^* with $N \geq 3$ cells such that

- (a) every cell in \mathcal{N}^* has the same number of inputs,
- (b) if we delete all inputs to cells of \mathcal{N}^* coming from outside \mathcal{N}^* , then the resulting network is either \mathcal{P}_N or \mathcal{Q}_N (up to a relabelling of cells),
- (c) when we reinsert the deleted connections then the invariant subspace structure of \mathcal{N}^* is unchanged

Under these conditions we expect to be able to choose 1-dimensional dynamics on nodes so that \mathcal{N}^* supports heteroclinic cycles along the lines of proposition 5.1. More generally, we expect the same result if instead of (c) we assume an invariant subspace structure on \mathcal{N} which induces the given invariant subspace structure on \mathcal{N}^* . In particular, for the heteroclinic network on \mathcal{N}^* , cells outside \mathcal{N}^* may need to be synchronized. We refer to figure 12 for a simple variation on example 5.3. In this case we take \mathcal{N}^* to be the network with cells A_1, A_2, A_3 . If we remove all inputs to cells in \mathcal{N}^* from cells outside \mathcal{N}^* , we recover the network \mathcal{P}_3 . In this case $\{A_1, A_2\}$, $\{A_1, A_3\}$, $\{A_1, A_2, A_3\}$ are not invariant subspaces for \mathcal{N} . However, $\{A_4, A_5\}$ is an invariant subspace and so also are

$$\{A_1, A_2 \parallel A_4, A_5\}, \{A_1, A_2 \parallel A_4, A_5\}, \{A_1, A_2, A_3 \parallel A_4, A_5\}.$$

(We follow the notational conventions of section 2).

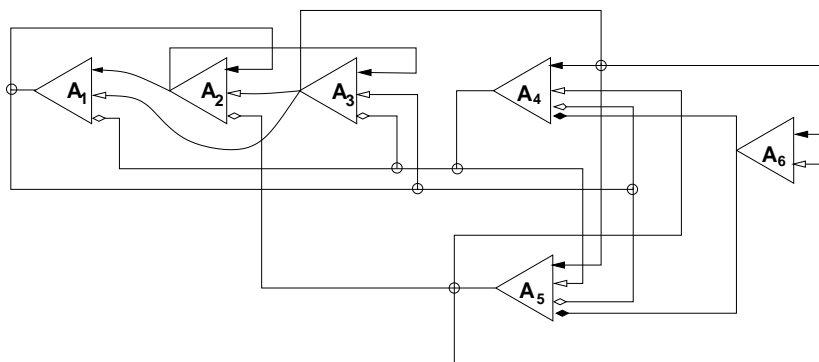

FIGURE 12. A 6 cell heterogenous network with additive input structure.

6. GENERALIZATIONS

The heteroclinic networks constructed in the previous sections have the feature that transition between nodes is marked by a desynchronization of one cell along the trajectory. With the exception of the examples on heterogeneous networks, in the constructed heteroclinic networks, nodes always correspond to fully synchronized equilibria. In the past there have been a number of works considering heteroclinic networks where trajectories correspond to patterns of desynchronization and resynchronization and transition between synchronized clusters. For example, the work of Ashwin *et al.* on computation and systems of phase oscillators with S_N -symmetry [8, 11, 10, 56], and that of Timme *et al.* on pulse coupled symmetric networks [51, 53, 54]. Elsewhere, Field [26, Chapter 7] constructs robust heteroclinic cycles between groups of active and quiescent nodes.

It is not hard to realize in \mathcal{P}_n robust heteroclinic networks that exhibit more complex patterns of desynchronization and resynchronization. As a general rule, for simple heteroclinic networks, we expect desynchronization of just one cell along connecting trajectories. If unstable manifolds are of dimension greater than 1, then two or more cells may desynchronize along connecting trajectories. This behaviour is well-known for phase oscillator systems with S_n -symmetry. Rather than give a general result, we give an example which illustrates the general method, and conclude with a conjecture.

Example 6.1 (cf [26, Example 7.22]). We construct a simple heteroclinic network Σ in \mathcal{P}_4 such that

- (1) Cell dynamics is 1-dimensional.
- (2) Σ has three equilibria $\mathbf{p}_j \in P_j \setminus \Delta(\mathbb{R})$ and three connections $\gamma_j \subset \{\mathbf{x} \mid x_1 = x_j\}$, $j \in \{2, 3, 4\}$.

Each node of Σ corresponds to a cluster of 3 synchronized cells. Along a connection just two cells are synchronized and the equilibria at the ends of the connection correspond to synchronized clusters with exactly two cells in common. We refer to figure 13 showing how Σ relates to the underlying invariant subspace structure in \mathcal{P}_4 .

We start by choosing the points $\mathbf{p}_j \in P_j \setminus \Delta$. It is straightforward to choose network dynamics F on a neighbourhood U of $\{\mathbf{p}_j \mid j = 2, 3, 4\}$ such that each \mathbf{p}_j is a hyperbolic saddle of index 1 and

- (a) $W^u(\mathbf{p}_2) \subset \{\mathbf{x} \mid x_1 = x_3\}$, $W^u(\mathbf{p}_4) \subset \{\mathbf{x} \mid x_1 = x_2\}$ and $W^u(\mathbf{p}_3) \subset \{\mathbf{x} \mid x_1 = x_4\}$ (see figure 13).
- (b) Restricted to P_j , \mathbf{p}_j is an attracting equilibrium.

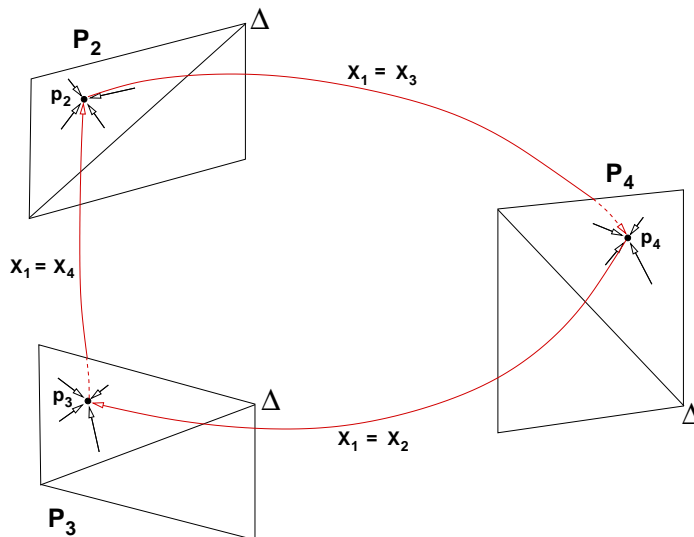

FIGURE 13. The heteroclinic cycle Σ in \mathcal{P}_4

Just as in the proof of theorem 4.4, we choose connections $\gamma_j \subset \{\mathbf{x} \mid x_1 = x_j\}$ joining the equilibria such that within U each connection is a trajectory of F . Consider the connection γ_3 joining \mathbf{p}_2 to \mathbf{p}_4 . In order that γ_3 be a trajectory in the network dynamics, we must be able to choose $f : \mathbb{R} \times \mathbb{R}^3 \rightarrow \mathbb{R}$ so that along γ_3 we have

$$\begin{aligned} x'_1 &= f(x_1; x_2, x_1, x_4) \\ x'_2 &= f(x_2; x_1, x_1, x_4) \\ x'_4 &= f(x_4; x_2, x_1, x_1) \end{aligned}$$

Outside of the neighbourhood U , we can certainly choose f along γ_3 to satisfy these equations (note that near \mathbf{p}_2 and \mathbf{p}_3 there are constraints). The corresponding equations for γ_2 are

$$\begin{aligned}x'_1 &= f(x_1; x_1, x_3, x_4) \\x'_3 &= f(x_3; x_1, x_1, x_4) \\x'_4 &= f(x_4; x_1, x_3, x_1)\end{aligned}$$

Observe that the second component of both vector fields is the same. So choose γ_2, γ_3 so that the projections into P_4 are either disjoint or meet transversally at one point. We handle similarly the projections of γ_2, γ_4 in P_3 and γ_3, γ_4 in P_2 and, with the usual identification of P_j with \mathbb{R}^2 , we may require that the set of intersection points is distinct. Now deform the γ_j in a small neighbourhood of each intersection point to achieve compatibility – just as in the proof of theorem 4.4. Finally extend f from $U \cup \cup_j \gamma_j$ to all of $\mathbb{R} \times \mathbb{R}^3$. We remark that using the same technique we can require $W^u(\mathbf{p}_j) \subset W^s(\mathbf{p}_{j-1})$, $j = 2, 3, 4$ (where \mathbf{p}_1 is to be taken as \mathbf{p}_4) and that the corresponding heteroclinic network is attracting.

Conjecture

Suppose $\Gamma(N, E) = \Gamma$ is a graph satisfying (C1,C2). Let m, r be chosen such that $m \geq 2$, $m > r \geq 1$ and $E \leq \binom{m}{r}(m-r)^2$. Then we may realize Γ as the graph of a heteroclinic network Σ in \mathcal{P}_{m+1} and Σ is well adapted and strict. Each equilibrium in Σ will lie in an invariant subspace $x_1 = x_{i_1} = \dots = x_{i_{r+1}}$, where $1 < i_1 < \dots < i_{r+1}$, and each connection will lie in an invariant subspace $x_1 = x_{j_1} = \dots = x_{j_r}$, where $1 < j_1 < \dots < j_r$.

The conjecture holds in case $r+1 = m = E$ by theorem 4.4. Example 6.1 verifies the conjecture when $m = 3$, $r = 1$ and $E = 3$ ($3 \leq \binom{3}{1} \times 4$ and note that method used in the example continues to work in case we allow for twin connections both ways in which case $E = 12$.)

7. DISCUSSION AND CONCLUDING COMMENTS

We conclude with some open questions relating to our results and examples.

The use of general sequences of identical coupled cells designed to realize all heteroclinic networks necessarily comes at a price. For example, the sequences $(\mathcal{P}_n), (\mathcal{Q}_n)$ are highly connected and use asymmetric inputs. While the connectivity can certainly be reduced (for example, if we use a heterogeneous additive input model), it is not so easy to reduce the number of input types. However, it is possible to realize quite complex heteroclinic networks in \mathcal{P}_n for small values of n – where

n depends mainly on the maximal out- and in-degrees of vertices in the graph of the heteroclinic network (see section 3).

While asymmetric inputs are appropriate for some classes of model (for example, power grid models [30, 19]), many spiking neural models effectively assume symmetric inputs (and additive input structure). It would be helpful to have an idea of the extent to which one can realize robust heteroclinic networks in identical cell systems with symmetric inputs but no global symmetries. In particular, are there sequences of identical cells with symmetric inputs that allow realization of large classes of heteroclinic networks? Is it necessary to consider networks with multiple cell types but with most cells of the same type?

The sequences (\mathcal{P}_n) , (\mathcal{Q}_n) handle the general embedding problem. It is natural to ask whether we can construct other sequences for which we can efficiently realize specific classes of heteroclinic network. For example, ‘scale free heteroclinic networks’ which have some highly connected vertices or “hubs” (likely relevant for applications tied to computing [8, 54]). Here it might well be appropriate to consider sequences with more than one cell type (one cell type for highly connected nodes – hubs – and a different cell type for cells with low connectivity). Indeed, introducing more than one cell type is already suggested by the special role that the node A_1 plays in our realization theorem (a similar phenomenon happens in Ashwin and Postlethwaite’s cylinder realization [13]).

Is there a natural way to move from realization of heteroclinic networks in a semi-linear feedback model to an identical coupled cell system? (See [28] for some past work, emphasizing heteroclinic cycles.)

There is the question of why the realization is more difficult when there is 1-dimensional cell dynamics. While 1-dimensional cell dynamics is often favoured from the mathematical point of view, in physical problems nodes will rarely have 1-dimensional dynamics. It is not, however, that higher dimensional cell dynamics is easier; the problem lies with the unrealistic assumption that inputs depend on the states of other cells. At this time, as far as we are aware, very little is known about the dynamics of coupled systems with more realistic coupling such as the scalar signalling model briefly discussed in section 2. For example, is there any physical reason why 1-dimensional signals might be preferred over 2-dimensional signals (for example, signals containing both amplitude and phase information)? This question relates to problems in control theory – how much information needs to be communicated for effective control? In terms of synchronization of spiking

neuron's, does information on spike times alone suffice to ensure synchronization in networks where there is 1-dimensional signalling but high dimensional node dynamics?

Finally, the heteroclinic networks we construct are not usually attractors – a consequence of our assumptions that allow unstable manifolds of equilibria to be of dimension 2 or greater. There is the difficult question of whether or not we can construct the realization so that it is contained in a ‘minimal’ heteroclinic attractor. Outside the case of realization of heteroclinic cycles as attractors, rather little appears to be known about this problem (see also the discussion in [13, §2]).

Acknowledgements

We thank Peter Ashwin for helpful comments on preliminary drafts of the paper and the referees for their remarks and questions which have led to clarifications and improvements in the exposition.

REFERENCES

- [1] M Abeles, H Bergman, I Gat, I Meilijson, E Seidmann & M Tishby, ‘Cortical activity flips among quasi-stationary states’, *PNAS* **92** (1995), 8616–8620.
- [2] V S Afraimovich, M I Rabinovich & P Varona. ‘Heteroclinic contours in neural ensembles and the winnerless competition principle’, *Inter. J. Bifur. Chaos* **14** (2004), 1195–1208.
- [3] V S Afraimovich, V P Zhigulin & M I Rabinovich. ‘On the origin of reproducible sequential activity in neural circuits’, *Chaos* **14**(4) (2004), 1123–1129.
- [4] N Agarwal & M Field. ‘Dynamical equivalence of networks of coupled dynamical systems I: Asymmetric inputs’, *Nonlinearity* **23** (2010), 1245–1268.
- [5] N Agarwal & M Field. ‘Dynamical equivalence of networks of coupled dynamical systems II: general case’, *Nonlinearity*, **23** (2010), 1269–1289.
- [6] M A D Aguiar, P Ashwin, A Dias & M Field. ‘Dynamics of coupled cell networks: synchrony, heteroclinic cycles and inflation’, *Journal of Nonlinear Science*, **21**(2) (2011), 271–323.
- [7] M A D Aguiar, S B S D Castro & I S Labouriau. ‘Dynamics near a heteroclinic network’, *Nonlinearity* **18**(1) (2005), 391–414.
- [8] P Ashwin & J Borresen, ‘Discrete computation using a perturbed heteroclinic network’, *Phys. Rev. E* **70** (2004), 026203.
- [9] P Ashwin, O Burylko & Y Maistrenko. ‘Bifurcation to heteroclinic cycles and sensitivity in three and four coupled phase oscillators’, *Phys. D* **237**(4) (2008), 454–466.
- [10] P Ashwin, G Orosz & J Borresen. ‘Heteroclinic Switching in Coupled Oscillator Networks: Dynamics on Odd Graphs’, *Nonlinear Dynamics and Chaos: Advances and Perspectives, Understanding Complex Systems*, M Thiel, J Kurths, M C Romano, A Moura & G Károlyi eds., Springer, (2010), 31–50.
- [11] P Ashwin, G Orosz, J Wordsworth & S Townley, ‘Reliable switching between cluster states for globally coupled phase oscillators’, *SIAM Journal on Applied Dynamical Systems* **6**, (2007), 728–758.
- [12] P Ashwin & M Field. ‘Heteroclinic networks in coupled cell systems’, *Arch. Rational Mech. Anal.* **148** (1999), 107–143.

- [13] P Ashwin & C M Postlethwaite. ‘On designing heteroclinic networks from graphs’, *Physica D* **265** (2013), 26–39..
- [14] P Ashwin & J W Swift. ‘The dynamics of n weakly coupled identical oscillators’, *J. Nonlinear Science* **2** (1992), 69–108.
- [15] C Bick & M J Field. ‘Asynchronous Networks and Event Driven Dynamics’, preprint, 2015.
- [16] C-W Chi, S-B Hsu & L-I Wu. ‘On the asymmetric May-Leonard model of three competing species’, *SIAM J. Appl. Math.* **58** (1998), 211–226.
- [17] A P S Dias, B Dionne & I Stewart. ‘Heteroclinic Cycles and Wreath Product Symmetries’, *Dynamics and Stability of Systems* **15** (2000), 353–385.
- [18] A P S Dias & I Stewart. ‘Linear equivalence and ODE-equivalence for coupled cell networks’, *Nonlinearity* **18** (2005), 1003–1020.
- [19] F Dörfler & F Bullo. ‘Synchronization and transient stability in power networks and non-uniform Kuramoto oscillators’, *SIAM Journal on Control and Optimization* **50** (3) (2012), 1616–1642.
- [20] F Dörfler, M Chertkov & F Bullo. ‘Synchronization in Complex Oscillator Networks and Smart Grids’, *PNAS* **110**(6) (2013), 2005–2010.
- [21] G Duffing. *Erzwungene schwingungen bei ver anderlicher eigenfrequenz und ihre technische Bedeutung* (Verlag Friedr, Vieweg & Sohn, Braunschweig, 1918).
- [22] M J Field. ‘Equivariant dynamical systems’, *Bull. Amer. Math. Soc.* **76** (1970), 1314–1318.
- [23] M J Field. ‘Transversality in G -manifolds’, *Trans. Amer. Math. Soc.* **231** (1977), 429–450.
- [24] M J Field. ‘Equivariant dynamical systems’, *Trans. Amer. Math. Soc.* **259**(1) (1980), 185–205.
- [25] M J Field & R W Richardson. ‘Symmetry breaking and branching patterns in equivariant bifurcation theory II’, *Arch. Rational Mech. and Anal.* **120** (1992), 147–190.
- [26] M J Field. *Dynamics, Bifurcation and Symmetry*, Pitman Research Notes in Mathematics, **356**, 1996.
- [27] M J Field. ‘Combinatorial Dynamics’, *Dynamical Systems* **19** (2004), 217–243.
- [28] M J Field. Unpublished notes and talks given in 2005 on Heteroclinic cycles and coupled cell systems (talks accessible at URL: math.rice.edu/~mjf8/research/networks/SLF).
- [29] M J Field. *Dynamics and Symmetry* (Imperial College Press Advanced Texts in Mathematics — Vol. 3, 2007.)
- [30] G Filatrella, A H Nielsen & N F Pederson. ‘Analysis of a power grid using a Kuramoto-like model’, *Eur. Phys. J. B* **61** (2008), 485.
- [31] D Fricker & R Miles. ‘EPSP Amplification and the precision of Spike Timing in Hippocampal Neurons’, *Neuron* **28** (2000), 559–569.
- [32] M Golubitsky, M Pivato & I Stewart. ‘Interior symmetry and local bifurcation in coupled cell networks’. *Dynamical Systems* **19** (2004), 389–407.
- [33] M Golubitsky & I Stewart. ‘Nonlinear dynamics of networks: the groupoid formalism’. *Bull. Amer. Math. Soc.* **43** (2006), 305–364.
- [34] M Golubitsky, I Stewart & A Török. ‘Patterns of Synchrony in Coupled Cell Networks with Multiple Arrows’, *SIAM J. Appl. Dynam. Sys.* **4**(1) (2005), 78–100.

- [35] D Hansel, G Mato & C Meunier. ‘Phase dynamics for weakly coupled Hodgkin-Huxley neurons’, *Europhys Letts* **23** (1993), 367–372.
- [36] D Hansel, G Mato & C Meunier. ‘Clustering and slow switching in globally coupled phase oscillators’, *Phys. Rev. E* **48**(5) (1993), 3470–3477. ‘Phase dynamics for weakly coupled Hodgkin-Huxley neurons’, *Europhys Letts* **23** (1993), 367–372.
- [37] J Hofbauer. ‘Heteroclinic cycles on the simplex’, *Proc. Int. Conf. Nonlinear Oscillations, Janos Bolyai Math. Soc. Budapest*, 1987.
- [38] J Hofbauer. ‘Heteroclinic cycles in ecological differential equations’, *Tatra Mountains Math. Publ.* **4** (1994), 105–116.
- [39] J Hofbauer & K Sigmund. *The Theory of Evolution and Dynamical Systems*, Cambridge University Press, Cambridge, 1988.
- [40] J Hofbauer & K Sigmund. *Evolutionary Games and Replicator Dynamics*, Cambridge University Press, Cambridge, 1998.
- [41] A J Homburg & J Knobloch. ‘Switching homoclinic networks’, *Dynamical Systems* **25**(3) (2010), 351–358.
- [42] V Kirk, E Lane, C M Postlethwaite, A M Rucklidge & M Silber. ‘A mechanism for switching near a heteroclinic network’, *Dynamical Systems: An International Journal*, **25**(3) (2010), 323–349.
- [43] I Kiss, C Rusin, H Kori & J Hudson. ‘Engineering complex dynamical structures: sequential patterns and desynchronization’, *Science* **316** (2007), 1886–9.
- [44] V Kirk & M Silber. ‘A competition between heteroclinic cycles’, *Nonlinearity* **7**(6) (1994), 1605–1622.
- [45] M Krupa. ‘Robust heteroclinic cycles’, *Journal of Nonlinear Science* **7** (1997), 129–176.
- [46] M Krupa & I Melbourne. ‘Asymptotic stability of heteroclinic cycles in systems with symmetry’, *Ergod. Th. & Dynam. Sys.* **15** (1995), 121–147.
- [47] M Krupa & I Melbourne. ‘Asymptotic stability of heteroclinic cycles in systems with symmetry, II’, *Proc. Roy. Soc. Edinburgh A* **134A** (2004), 1177–1197.
- [48] K K Lin & L-S Young. ‘Shear-induced chaos’, *Nonlinearity* **21** (2008), 899–922.
- [49] R M May & W J Leonard. ‘Nonlinear aspects of competition between three species’, *SIAM J. Appl. Math.*, **29** (1975), 243–253.
- [50] I Melbourne, P Chossat & M Golubitsky. ‘Heteroclinic cycles involving periodic solutions in mode interactions with $O(2)$ symmetry’, *Proc. Roy. Soc. Edinburgh* **113A** (1989), 315–345.
- [51] R-M Memmesheimer & M Timme. ‘Designing the Dynamics of Spiking Neural Networks’, *Phys. Rev. Letts* **97** (2006), 188101.
- [52] A Mohapatra & W Ott. ‘Homoclinic loops, heteroclinic cycles and rank one dynamics’, *SIAM Jnr. Appl. Dyn. Sys.*, to appear.
- [53] F S Neves & M Timme. ‘Controlled perturbation-induced switching in pulse-coupled oscillator networks’, *J. Phys. A: Math. Theor.* **42** (2009), 345103.
- [54] F S Neves & M Timme. ‘Computation by switching in complex networks’, *Phy. Rev. Lett.* **109** (2012), 751–811.
- [55] T Nowotny & M Rabinovich. ‘Dynamical Origin of Independent Spiking and Bursting Activity in Neural Microcircuits’, *Phys. Rev. Letts* **98** (2007), 128106.
- [56] G Orosz, J Moehlis & P Ashwin. ‘Designing the dynamics of globally coupled oscillators’, *Progress of Theoretical Physics*, **122**(3) (2009), 611–630.

- [57] M M Peixoto. ‘On an approximation theorem of Kupka and Smale’, *J. Diff. Eqn.* **3** (1966), 214–227.
- [58] M Rabinovich, R Huerta & G Laurent. ‘Transient Dynamics for Neural Processing’, *Science* **321** (2008), 48–50.
- [59] M Rabinovich, A Volkovskii, P Lecanda, R Huerta, H D I Abarbanel & G Laurent. ‘Dynamical encoding by networks of competing neuron groups: Winnerless competition’, *Phys. Rev Lett* **8706**(8102) (2001), 149–141.
- [60] G L dos Reis. ‘Structural stability of equivariant vector fields on two manifolds’, *Trans. Amer. Math. Soc.*, **283** (1984), 633–643.
- [61] M Rohden, A Sorge, M Timme & D Witthaut. ‘Self-Organized Synchronization in Decentralized Power Grids’, *Phys. Rev. Lett.* **109** (2012).
- [62] L P Shilnikov, A L Shilnikov, D V Turaev & L O Chua. *Methods of Qualitative Theory in i Nonlinear Dynamics, Part 1* (World Scientific, Singapore, 1998).
- [63] A L Shilnikov, D V Turaev, L O Chua & L P Shilnikov. *Methods of Qualitative Theory in Nonlinear Dynamics, Part 2* (World Scientific, Singapore, 2002).
- [64] I Stewart, M Golubitsky & M Pivato. ‘Symmetry groupoids and patterns of synchrony in coupled cell networks’, *SIAM J. Appl. Dynam. Sys.* **2** (4) (2003), 606–646.
- [65] Q Wang & W Ott. ‘Dissipative homoclinic loops of two-dimensional maps and strange attractors with one direction of instability’, *Comm. Pure Appl. Math.*, **64** (2011), 1439–1496.
- [66] Q Wang & L-S Young. ‘Strange attractors in periodically-kicked limit cycles and Hopf bifurcations’, *Comm. Math. Phys.* **240** (2003), 509–529.

MICHAEL FIELD, DEPARTMENT OF MATHEMATICS, RICE UNIVERSITY, HOUSTON, TX 77005-1892, USA

Current address: Department of Mathematics, Imperial College, SW7 2AZ, UK
E-mail address: mikefield@gmail.com